

GP matic 24 Fast

 **CE** EN 14439

50/18

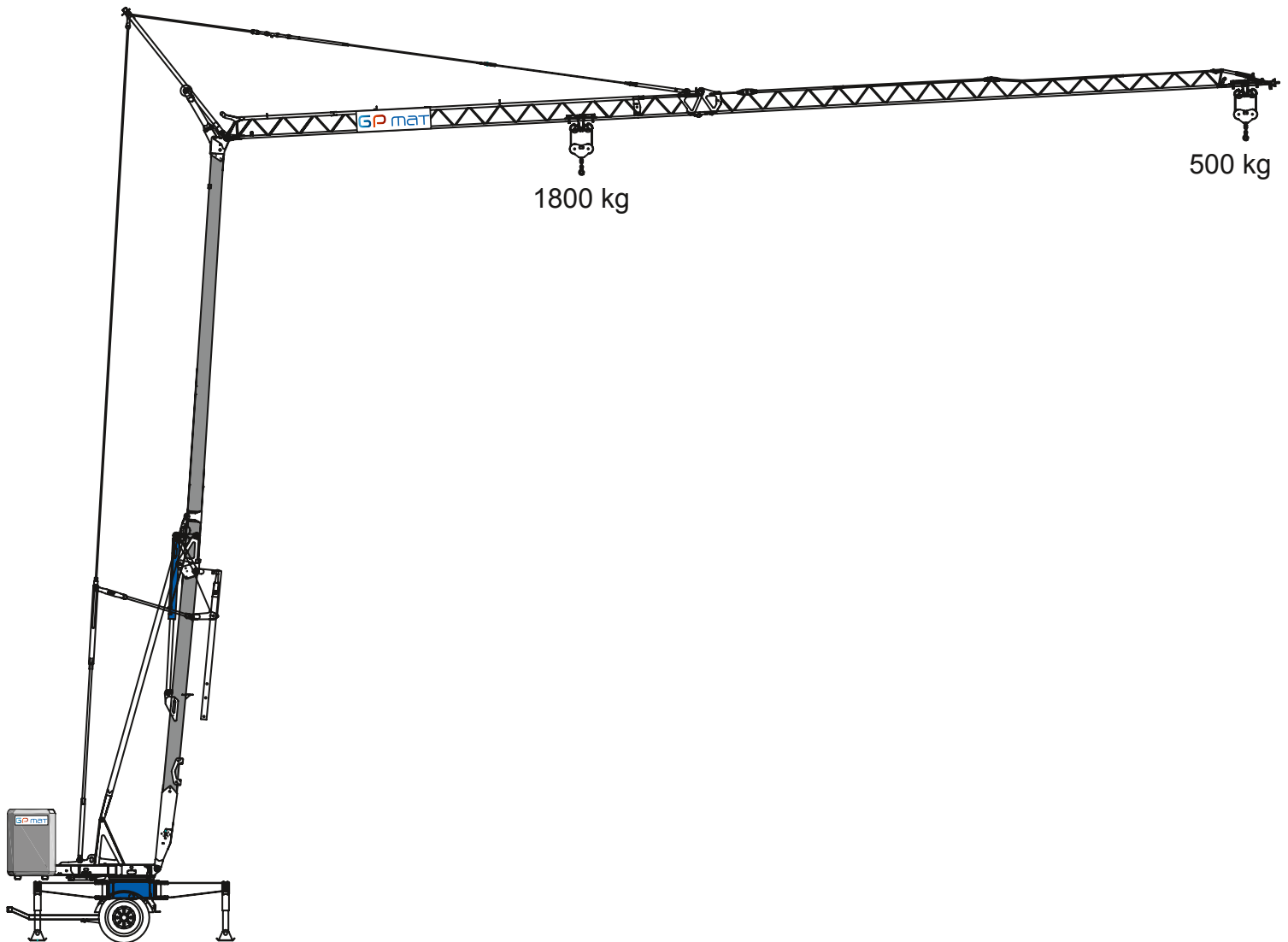

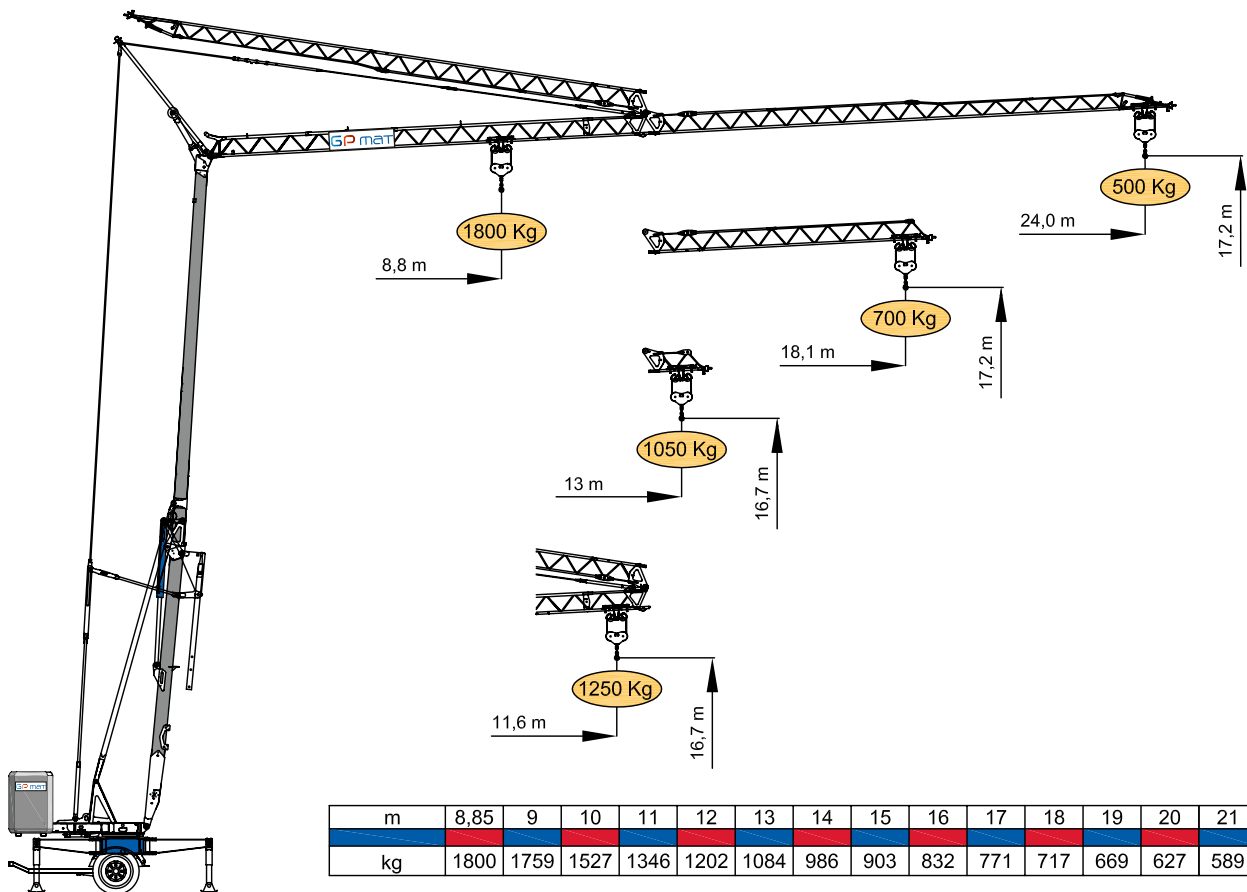
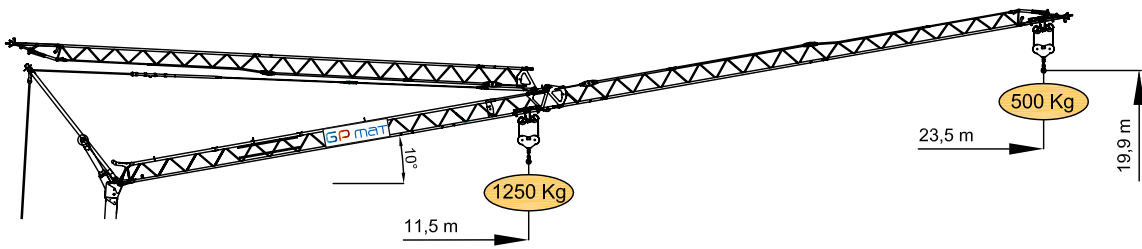
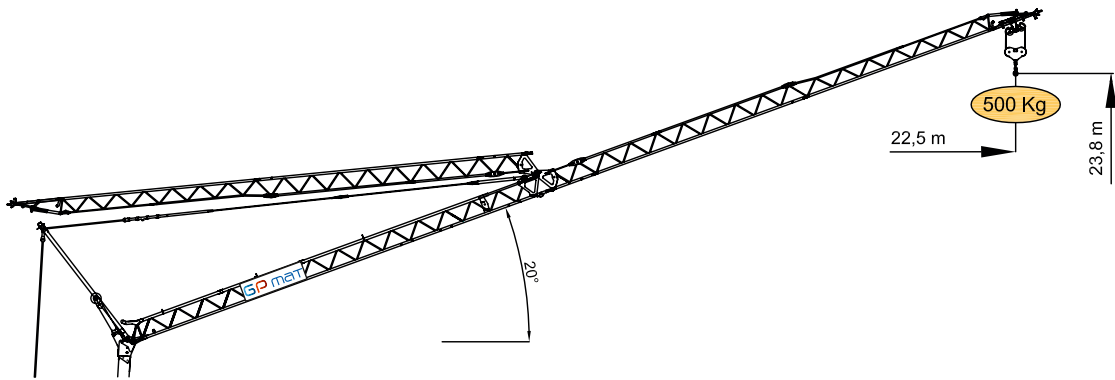

m	8,85	9	10	11	12	13	14	15	16	17	18	19	20	21	22	23	24
kg	1800	1759	1527	1346	1202	1084	986	903	832	771	717	669	627	589	555	524	500



DOTAZIONE DI SERIE

Sollevamento "overdrive" a 4 velocità con inverter, rotazione e carrello a tre velocità con inverter, zincatura della struttura e dei tiranti, contrappeso, braccio impennabile, carrello rampante con motore e finecorsa alla base della torre, funzionamento con braccio ripiegato, comando a pulsantiera via cavo, carter di protezione per ralla e meccanismi, predisposizione per radiocomando, armadio elettrico in acciaio inox, documentazione a norme CEE.

	50 Hz V +10%-10%	m/l'				
	230 V	3 kW kg	6.7	13.5	23.5	37
	4,5 kW kg	1800	1350	1800	750	500
400 V	6 kVA kg	1800	1800	750	750	750
kW 5.5 Inverter						



STANDARD FEATURES

4-speed lifting, 3-speed rotation and trolley with inverter control, galvanised structure, counterweight, pull-up jib, translation trolley with motor and limit switch at base of gantry, operation with folden jib, cable-operated pushbutton remote control, guard for slewing ring and mechanisms, designed to allow installation of radio control, stainless steel electrical cabinet, documentation in accordance with EU standards.

	m/l'			
	kW	11.8	18.9	35.4 (↗26)
kW 1.85 Inverter				

	n/l'			
	kW	0.22	0.56	0.12
kW 1.2 Inverter				

	min	
	kW	5
1.5		



EQUIPEMENT DE SERIE

Levage à quatre vitesses, chariot et rotation à trois vitesses à contrôle électronique, galvanisation de la structure et des tirants, contrepoids, flèche relevable, moteur de chariot et fin de course à la base de la tour, fonctionnement bras replié, commande par câble, carter de protection pour la couronne et les mécanismes, predisposition pour radio, armoire électrique en acier inox, documentation conforme aux normes CEE.

	25 - 80 km/h		7012 kg		2 x 2375 kg
--	--------------	--	---------	--	-------------



SERIENAUSSTATTUNG

Heben mit vier Geschwindigkeiten, Laufkatze und Rotation mit drei Geschwindigkeiten, Strukturverzinkung, Gegengewicht, hochklappbarer Arm, aufsteigender Wagen mit Motor und Anschlag an der Basis des Turms, Funktionieren mit eingeklapptem Arm, Steuerung mit Druckknopftaste via Kabel, Schutzvorrichtungen für Drehverbindungen und Mechanismen, Vorbereitung für Funksteuerung, elektrischer Schrank aus rostfreiem Stahl, Dokumentation gemäß EC Vorschriften.

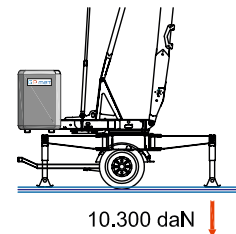
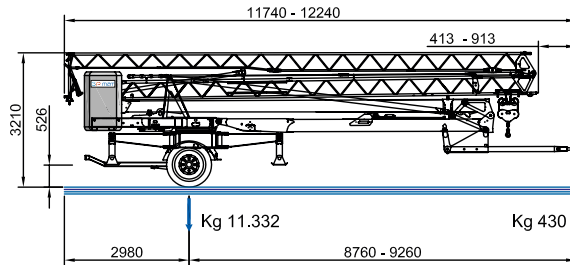

DOTACION DE SERIE

Levantamiento a cuatro velocidades, carro y rotación a tres velocidades con control electrónico, galvanización de la estructura, contrapeso, brazo empinnable, carro rampante con motor y fin de carrera en la base de la torre, funcionamiento con brazo repliegado, funcionamiento por pulsadores via cable, cárter de protección para corona de giro y mecanismos, predisposición para radiocomando, armario eléctrico de acero inox, documentación según normas CEE.

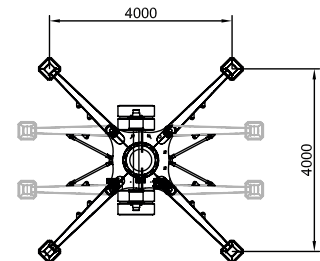
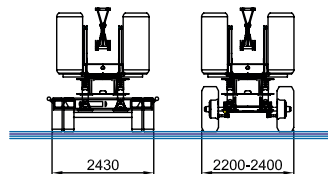

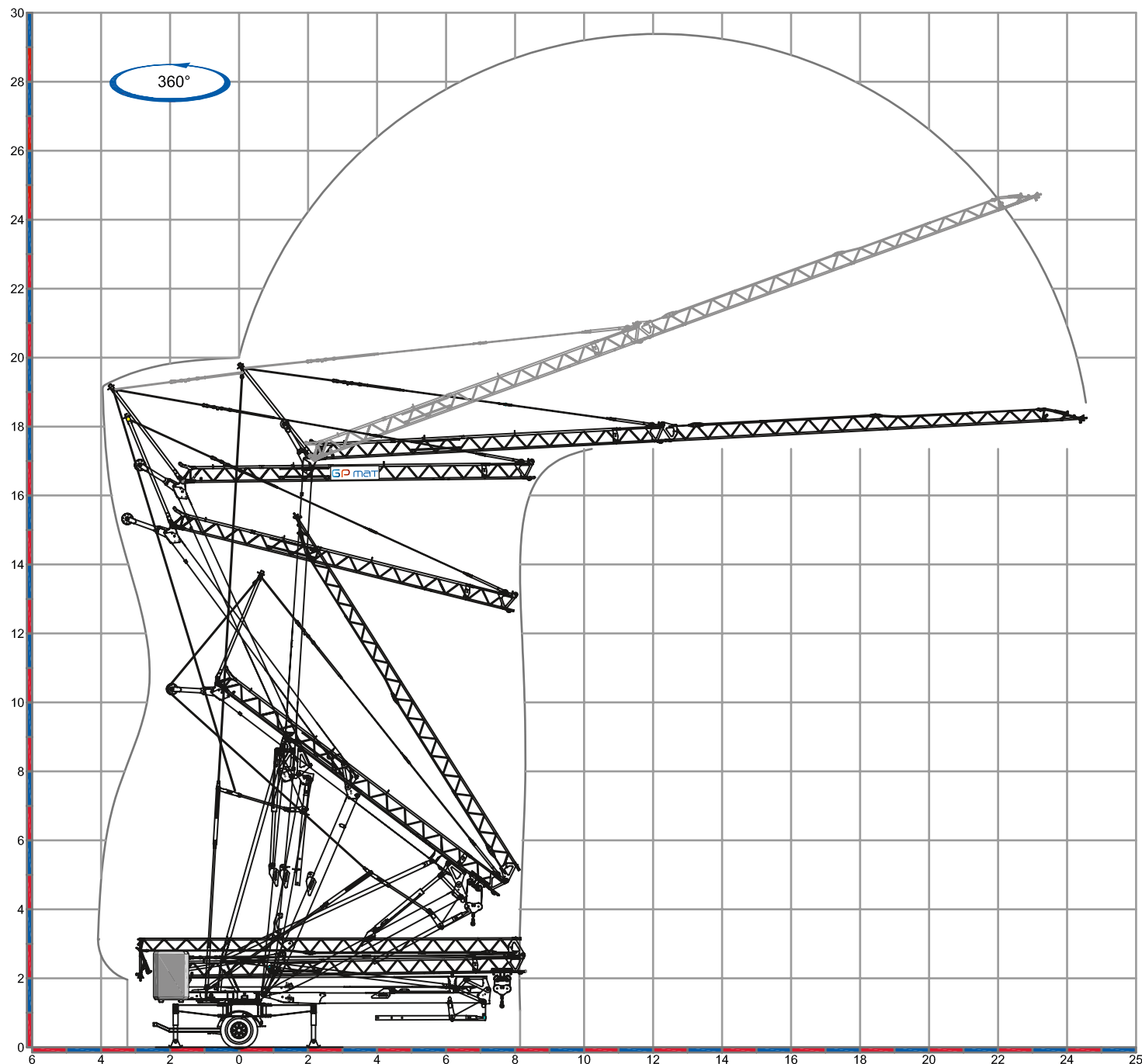

Déroulement de montage sur 360°

NANTES

5 Rue des Châtaigniers
 Parc d'Activités du Butay,
44690 CHATEAU-THEBAUD
 Tél. 02 40 78 10 10 - Fax 02 40 78 11 00

AVIGNON

163 Avenue du Grenache
 ZAC du Plan
84320 ENTRAIGUES SUR LA SORGUE
 Tél. 04 90 48 00 48 - Fax 04 90 48 00 00



contact@gpmat.fr - www.gpmat.fr



Filiale : GP MAT OCÉAN INDIEN

GP matic 24 Fast 50/18