

GHC140 Product Guide

ASME B30.5
Metric 75% and Imperial 75%



Features

- 127 t (140 USt) capacity
- 12,3 - 52,2 m (40.4 ft - 171.3 ft) six-section pin boom
- 15 m (49.3 ft) offsettable bi-fold swingaway
- 100% pick and carry load charts at .3°, 1.5°, and 4°
- Cummins QSB 6.7L Tier 4 final diesel engine
- Rear view, right side and hoist cameras
- High visibility cab with 20° tilt

GROVE GHC140

The GHC140 delivers heavy-duty lifting power and exceptional mid-range and maximum reach, with a boom length of 12,3 m - 52,2 m (40.4 ft – 171.3 ft).

Features

> Comfort redefined

Operator's cab is designed to deliver maximum comfort while incorporating conveniently located joystick controls for precise operation. Cab comes equipped with an integrated rated capacity limiter, air suspension seat, color monitor for up to four cameras, and precise climate control. The cab can tilt up to 20° providing the operator additional comfort when working at long boom and extension lengths.



> Travel made easy

Transportation to the job site can easily be accomplished in 3-5 loads. Set up time is minimal thanks to the GHC140's quick self-assembly system for both the counterweight and side frames. Once assembled the strong undercarriage provides 100% pick and carry capability and work up to 4° of inclination. The hydraulically extendable tracks allow for three working gauges for maximum flexibility on the job.



> Strong telescopic boom

The GHC140 comes equipped with a robust pin six-section boom that allows for telescoping under load. The main boom 12,3 m - 52,2 m (40.4 ft - 171.3 ft) of reach. This paired with the standard 15 m (49.3 ft) offsettable bi-fold swingaway extension provides a maximum tip height of 70 m (229.7 ft).



CraneSTAR

> CraneSTAR is an exclusive and innovative crane asset management system

that helps improve your profitability and reduce costs by remotely monitoring critical crane data.

Visit www.cranestar.com for more information.

GHC140 benefits

More productive in more places on the jobsite

The GHC140 delivers unsurpassed maneuverability and versatility.

- Telescoping boom, plus heavy-duty crawler tracks for all-terrain productivity
- Superior gradeability
- High visibility cabs with up to 20° tilt
- Two-speed hydrostatic drive allows for skid steering and counter-rotation capability
- Compact design allows you to work in more places

Rugged durability to tackle all terrain

The GHC140 comes equipped with a durable, powerful crawler system.

- Hydraulically extendable and retractable crawlers
- Heavy-duty, 900 mm (36 in) triple bar, maintenance-free track shoes
- Cummins QSB 6.7L Tier 3 or Tier 4 final diesel engines power through terrain challenges
- Easy self-assembling crawlers

Easy transport to the jobsite and quick assembly

The GHC140 helps you spend less time on the truck and more time on the job.

- Transports to the jobsite in three to five loads
- Retracted gauge for transport width
- Self-assembly counterweight
- Undercarriage frame with jacks for easy self assembly of crawlers
- Excellent serviceability keeps you up and running



Manitowoc Crane Care when you need it.

The assurance of the world's most advanced crane service and support to get you back to work fast.



Manitowoc Finance helps you get right to work generating profits for your business.

Financial tools that help you capitalize on opportunity with solutions that fit your needs.

Contents

Dimensions	5
Load programs	7
Transportation/assembly	8
Working range/load charts - main boom metric 75%	10
Load charts - auxiliary boom nose metric 75%	13
Working range/load charts - extensions metric 75%	14
Working range/ load charts - main boom imperial 75%	18
Load charts - auxiliary boom nose imperial 75%	21
Working range/load charts - extensions imperial 75%	22
Load handling	26
Specifications	27
Symbols glossary	29

Dimensions

Operating weight: approximately 119.2 t (131.4 USt) (two winches, with 15 m (49.2 ft) bi-fold jib, 80 t (88 USt) hook block, 35.3 t (38.9 USt) counterweight and crawlers with 900 mm (35.4 in) triple bar shoes.

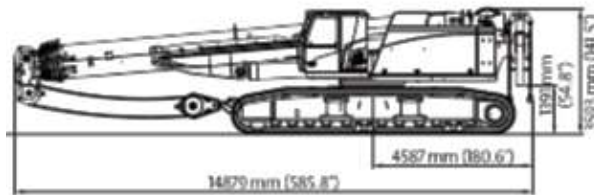
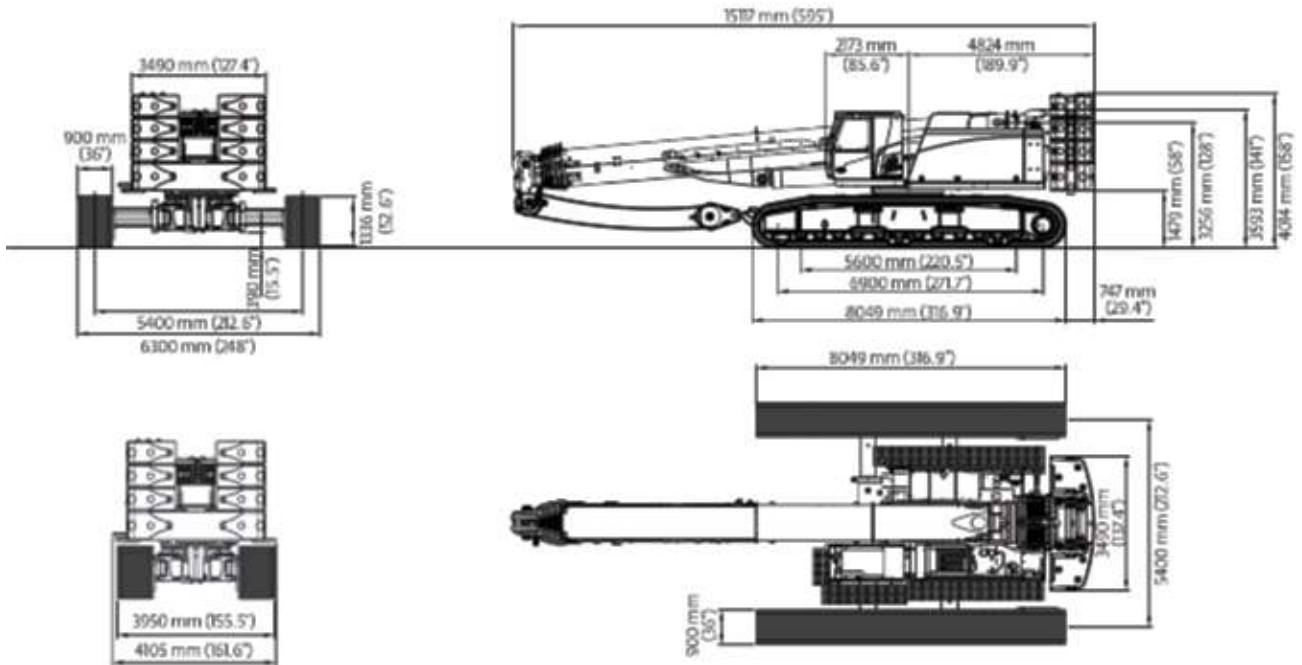

Transport weight: approximately 51,6 t (56.9 USt) (two winches, with 15 m (49.2 ft) bi-fold jib, 80 t (88 USt) hook block)

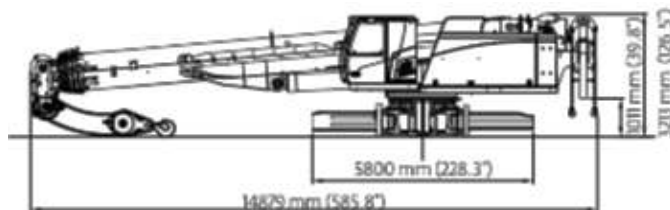

Dimensions

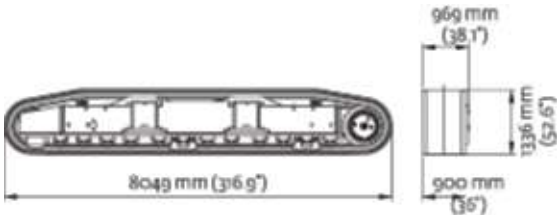

Crawler x 2

16 000 kg
(35,274 lb)

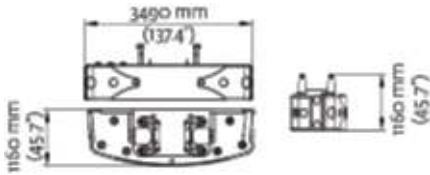

Base plate for counterweight x 1

14 150 kg
(31,195 lb)

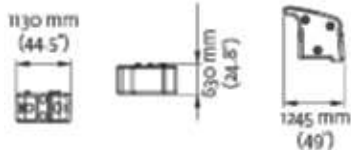

Counterweight x 6

3500 kg
(7,716 lb)

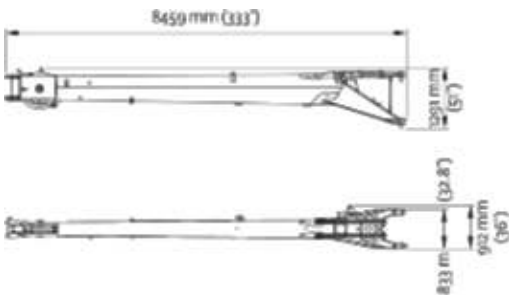

Flyjib - 8 m (26.3 ft)

920 kg
(2,028 lb)

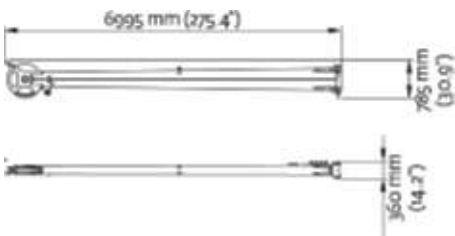

Flyjib extension - 7 m (23 ft)

300 kg
(661 lb)

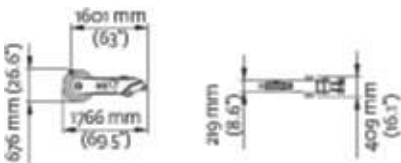

Auxiliary jib

160 kg
(353 lb)

















































Heavy duty jib

650 kg
(1,433 lb)

Load programs

Working load programs

	Main boom			Auxiliary boom nose			Heavy Duty jib 3 m (10 ft)		
									
Undercarriage track width (centerline to centerline of crawlers)	 5,4 m (17.7 ft)	 4,2 m (13.8 ft)	 3,1 m (10.0 ft)	 5,4 m (17.7 ft)	 4,2 m (13.8 ft)	 3,1 m (10.0 ft)	 5,4 m (17.7 ft)	 4,2 m (13.8 ft)	 3,1 m (10.0 ft)
Counterweight									
 35,3 t (77,836 lb)	360° 	360° 	—	360° 	360° 	—	360° 	360° 	—
 21,3 t (46,966 lb)	360° 	360° 	—	360° 	360° 	—	360° 	360° 	—
 0 t	360° 	360° 	360° 	360° 	360° 	360° 	360° 	360° 	—

	Boom extension 8 m (26.3 ft)			Boom extension with fly jib 15 m (49.3 ft)		
						
Undercarriage track width (centerline to centerline of crawlers)	 5,4 m (17.7 ft)	 4,2 m (13.8 ft)	 3,1 m (10.0 ft)	 5,4 m (17.7 ft)	 4,2 m (13.8 ft)	 3,1 m (10.0 ft)
Counterweight						
 35,3 t (77,836 lb)	360° 	—	—	360° 	—	—

Note:

Safe working loads are available for 0.3°, 1.5° and 4° inclines.

*THIS CHART IS ONLY A GUIDE AND SHOULD NOT BE USED TO OPERATE THE CRANE.
The individual crane's load chart, operating instructions and other instructional plates must be read and understood prior to operating the crane.*

Transportation / assembly

1

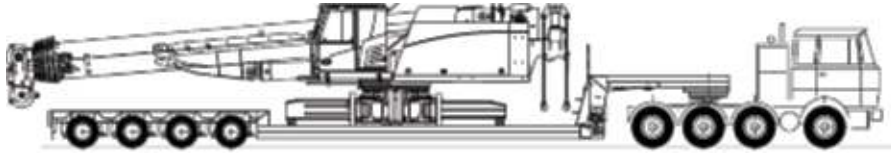

2

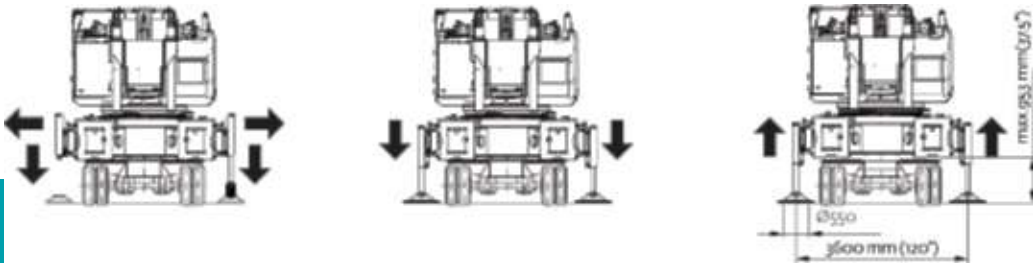

3

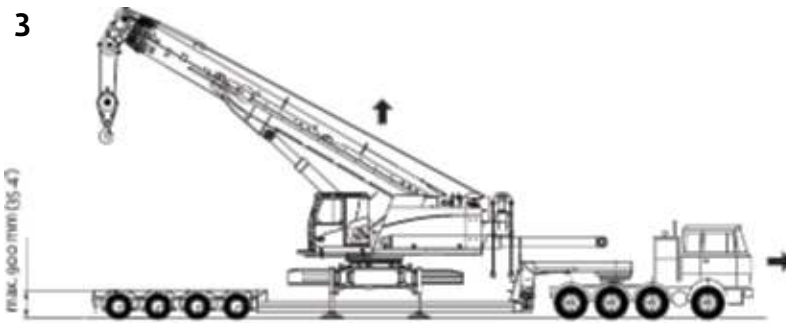

4

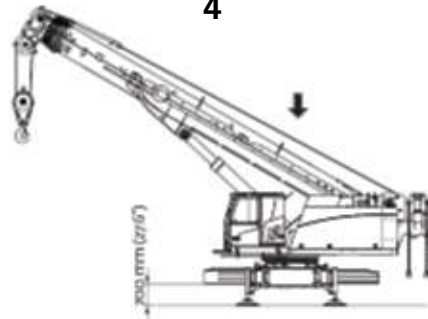

5

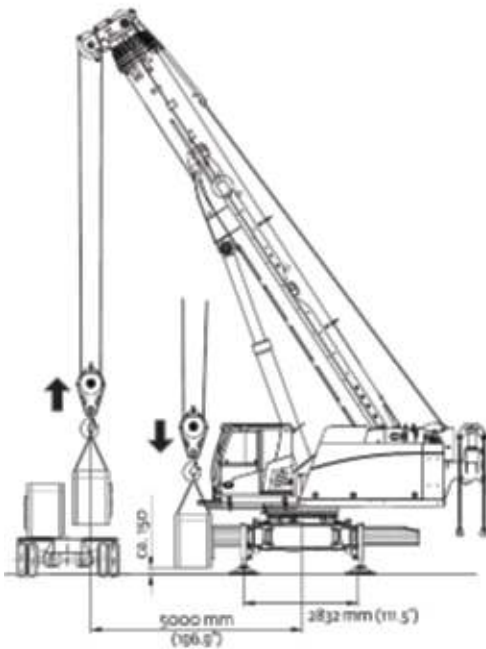

6

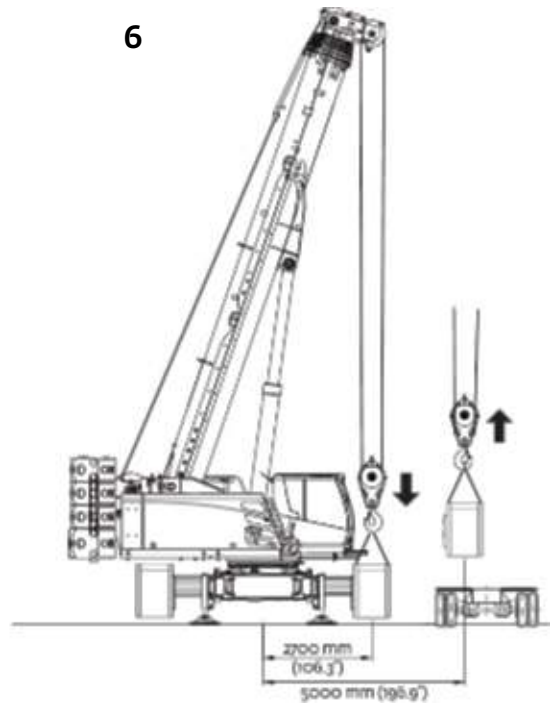

Transportation / assembly

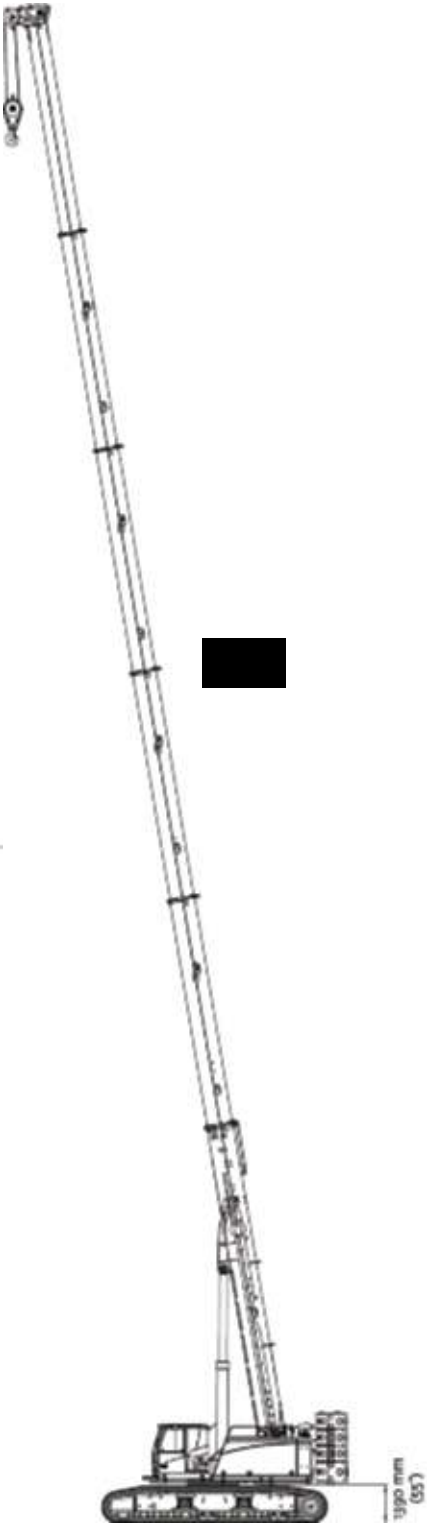
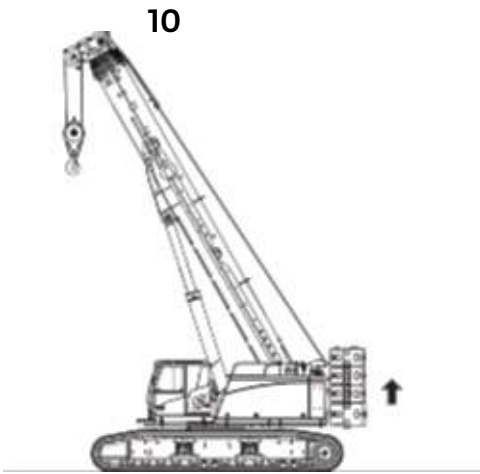

Working range

Main boom - metric 75%

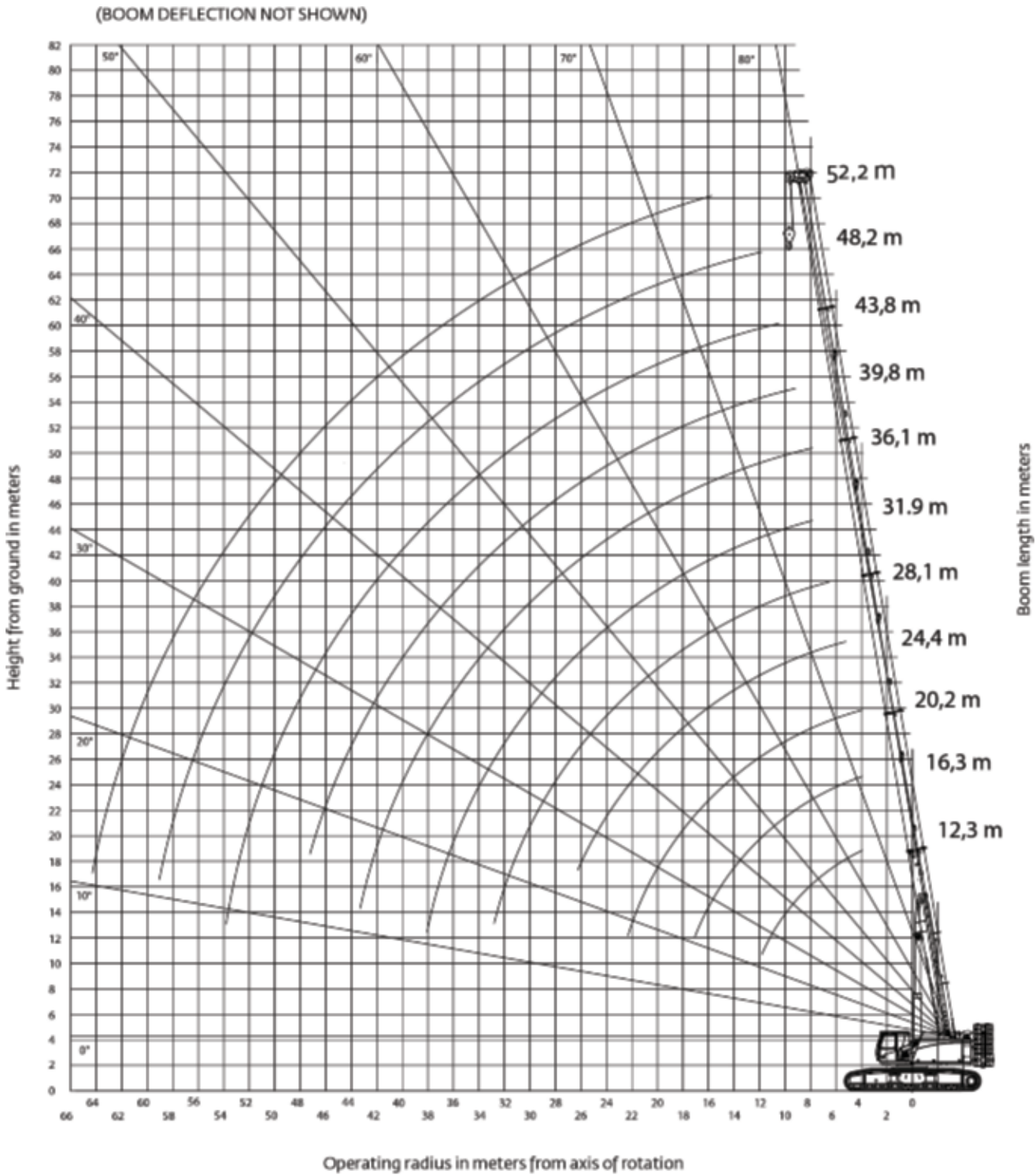

*THIS CHART IS ONLY A GUIDE AND SHOULD NOT BE USED TO OPERATE THE CRANE.
The individual crane's load chart, operating instructions and other instructional plates must be read and understood prior to operating the crane.*

Load chart

Main boom - metric 75%



52,2 m



35,3 t



100%



360°



0.3°



Kilograms

Radius [m]	Main boom length [m]											
	12,3	16,3	20	24	28	32	36	40	44	48,2	52,2	
3	127 000*	80 000	75 000									
4	111 000*	76 000	68 000	66 000	42 000							
5	90 000	72 000	65 000	58 000	55 000							
6	74 000	68 000	60 000	56 000	49 000	46 000	35 000					
7	62 000	62 000	57 000	53 000	47 000	42 000	33 000	25 000				
8	53 000	54 000	52 300	48 000	46 000	40 000	31 000	24 000	19 100			
9	47 000	47 600	48 000	45 900	43 000	39 000	29 500	23 000	18 600	14 500		
10		42 200	42 600	42 400	40 000	37 000	28 000	21 000	18 400	14 400		
12		32 400	34 000	34 200	33 900	33 000	25 400	19 000	16 600	14 200	11 800	
14		23 000	27 300	27 400	27 100	25 500	23 000	17 500	15 200	14 000	11 500	
16			22 400	22 500	22 300	21 000	21 200	16 000	14 100	13 300	11 300	
18				18 900	18 700	17 000	17 800	15 000	12 700	12 500	11 100	
20				16 200	15 900	15 000	15 100	14 000	11 800	11 700	10 900	
22					13 800	13 000	12 900	13 000	11 100	10 800	10 500	
24					12 000	11 000	11 100	12 000	10 400	10 000	9 900	
26						9 500	9 900	11 000	9 800	9 500	9 300	
28						8 500	9 400	9 500	9 200	8 900	8 700	
30							8 900	8 500	8 700	8 400	8 000	
32								7 800	7 700	7 500	7 100	
34									6 900	7 000	6 800	6 300
36									6 300	6 500	6 100	5 600
38										5 800	5 500	4 900
40										5 300	4 900	4 300
42											4 200	3 800
44											3 900	3 300
46												2 900
48												2 400

* Valid with special equipment

*THIS CHART IS ONLY A GUIDE AND SHOULD NOT BE USED TO OPERATE THE CRANE.
The individual crane's load chart, operating instructions and other instructional plates must be read and understood prior to operating the crane.*

Load chart

Main boom - metric 75%



52,2 m



35,3 t



100%



360°



1.5°



Kilograms

Radius [m]	Main boom length [m]										
	12,3	16	20	24	28	32	36	40	44	48	52,2
3	85 000	64 000	54 000								
4	80 000	64 000	57 000	50 000	42 000						
5	75 000	64 000	57 000	50 000	45 000						
6	70 000	64 000	57 000	50 000	45 000	35 000	30 500				
7	62 000	58 000	57 000	48 000	44 000	35 000	30 000	19 500			
8	53 000	54 000	52 300	47 400	43 000	35 000	29 000	19 000	15 300		
9	47 000	47 600	48 000	45 900	41 000	35 000	28 000	18 500	15 300	11 000	
10		42 200	42 600	42 400	39 000	34 000	27 000	18 300	15 300	11 000	
12		32 400	34 000	34 200	33 900	32 000	25 100	17 700	14 800	11 000	9 000
14		23 000	27 300	27 400	27 100	25 500	23 000	16 500	14 500	11 000	9 000
16			22 400	22 500	22 300	21 000	20 500	15 300	13 700	11 000	9 000
18				18 900	18 700	17 000	17 800	14 200	12 700	11 000	9 000
20				16 200	15 900	15 000	15 100	13 200	11 800	11 000	8 900
22					13 800	13 000	12 900	12 400	11 100	10 800	8 800
24					12 000	11 000	11 100	11 700	10 400	10 000	8 600
26						9 500	10 000	11 000	9 800	9 500	8 500
28						8 500	9 400	9 500	9 200	8 900	8 200
30							8 900	8 500	8 700	8 400	8 000
32							7 800	7 700	7 500	7 600	7 100
34							3 000	6 900	7 000	6 800	6 300
36								6 300	6 500	6 100	5 600
38									5 800	5 500	4 900
40									5 300	4 900	4 300
42										4 200	3 800
44										3 900	3 300
46											2 900
48											2 400

THIS CHART IS ONLY A GUIDE AND SHOULD NOT BE USED TO OPERATE THE CRANE.

The individual crane's load chart, operating instructions and other instructional plates must be read and understood prior to operating the crane.

Load chart

Auxiliary boom nose - metric 75%



52,2 m



With auxiliary
boom nose



35,3 t



100%



360°



1.5°



Kilograms

Radius [m]	Main boom length [m]										
	12,3	16,3	20,0	23,6	27,7	31,8	35,8	39,6	44,1	48,2	52,2
3	12 500	12 500	12 500								
4	12 500	12 500	12 500	12 500	12 500						
5	12 500	12 500	12 500	12 500	12 500	12 500					
6	12 500	12 500	12 500	12 500	12 500	12 500	12 500				
7	12 500	12 500	12 500	12 500	12 500	12 500	12 500	12 500			
8	12 500	12 500	12 500	12 500	12 500	12 500	12 500	12 500	12 500		
9	12 500	12 500	12 500	12 500	12 500	12 500	12 500	12 500	12 500	11 000	
10		12 500	12 500	12 500	12 500	12 500	12 500	12 500	12 500	11 000	
12		12 500	12 500	12 500	12 500	12 500	12 500	12 500	12 500	11 000	9 000
14		12 500	12 500	12 500	12 500	12 500	12 500	12 500	12 500	11 000	9 000
16			12 500	12 500	12 500	12 500	12 500	12 500	12 500	11 000	9 000
18			12 500	12 500	12 500	12 500	12 500	12 500	12 500	11 000	9 000
20				12 500	12 500	12 500	12 500	12 500	11 800	11 000	8 900
22				12 500	12 500	12 500	12 500	12 400	11 100	10 800	8 800
24					12 000	11 000	11 100	11 700	10 400	10 000	8 600
26						9 500	10 000	11 000	9 800	9 500	8 500
28						8 500	9 400	9 500	9 200	8 900	8 200
30							8 900	8 500	8 700	8 400	8 000
32							7 800	7 700	7 500	7 600	7 100
34							3 000	6 900	7 000	6 800	6 300
36								6 300	6 500	6 100	5 600
38									5 800	5 500	4 900
40									5 300	4 900	4 300
42										4 200	3 800
44										3 900	3 300
46											2 900
48											2 400

THIS CHART IS ONLY A GUIDE AND SHOULD NOT BE USED TO OPERATE THE CRANE.
The individual crane's load chart, operating instructions and other instructional plates must be read and understood prior to operating the crane.

Working range

Extensions - metric 75%

Main boom with extensions

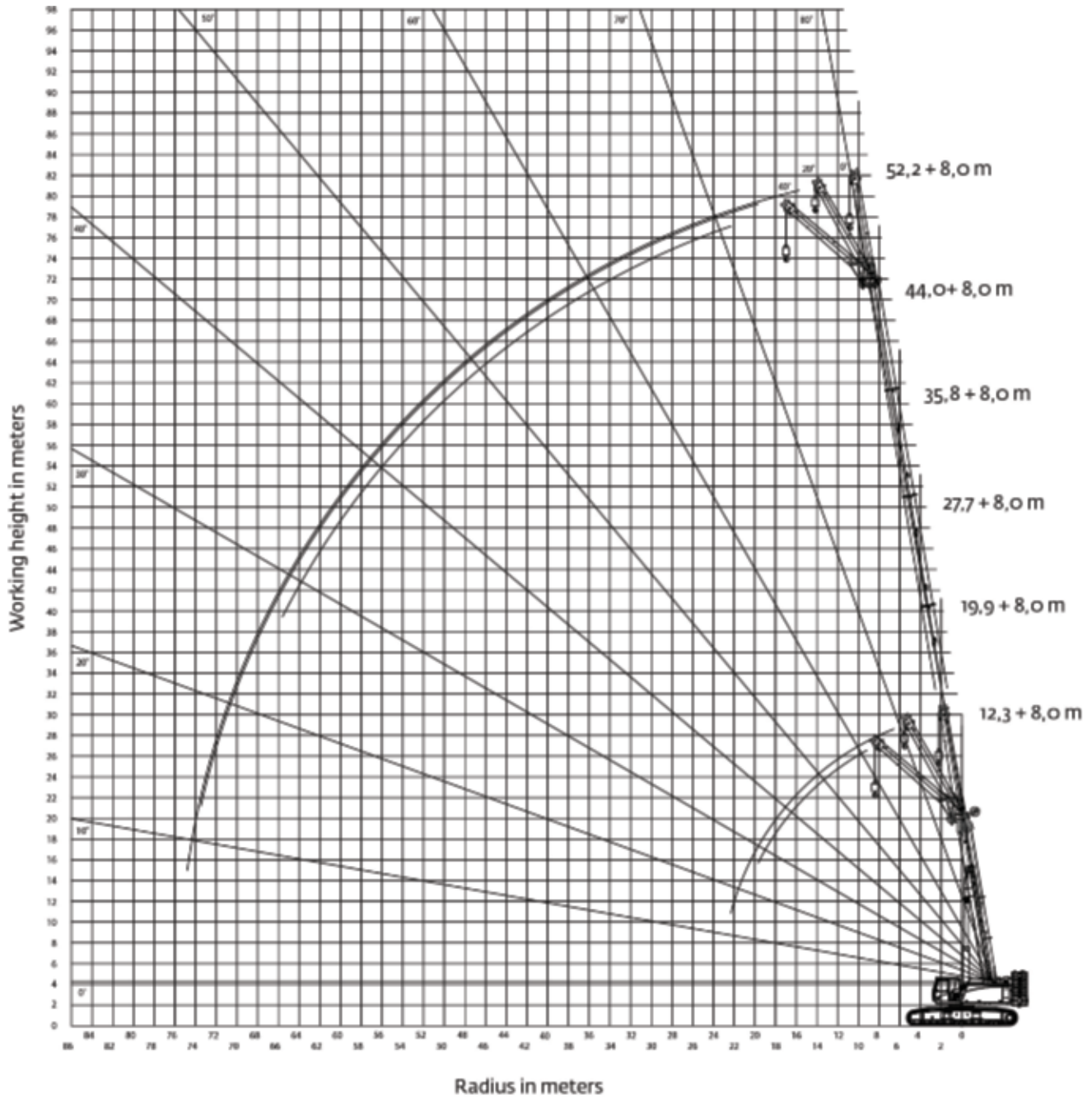

*THIS CHART IS ONLY A GUIDE AND SHOULD NOT BE USED TO OPERATE THE CRANE.
The individual crane's load chart, operating instructions and other instructional plates must be read and understood prior to operating the crane.*

Load chart

Extensions - metric 75%



52,2 m



8 m



35 t



100%



360°



0.3°



Kilograms

Radius [m]	Main boom length [m]																		
	12,3			19,9			27,7			35,8			44,0			52,2			
	0°	20°	40°	0°	20°	40°	0°	20°	40°	0°	20°	40°	0°	20°	40°	0°	20°	40°	
5	14 200	10 300		14 900			14 000												
6	12 900	9 600		14 000	9 900		13 400												
7	11 900	9 000	7 200	13 000	9 500		12 800			11 400									
8	10 900	8 500	6 900	12 300	9 100	7 000	12 200	9 000		11 200									
9	10 200	8 000	6 700	11 600	8 700	6 900	11 700	8 800		10 900									
10	9 500	7 600	6 500	10 900	8 300	6 700	11 200	8 500	6 700	10 700	8 300		9 500						
12	8 200	6 900	6 100	9 900	7 700	6 400	10 300	8 000	6 500	10 000	7 900	6 400	9 200			6 500			
14	7 200	6 400	5 800	9 000	7 200	6 100	9 500	7 500	6 200	9 400	7 500	6 200	8 900	7 400	6 000	6 500			
16	6 400	6 100	5 700	8 200	6 700	5 900	8 900	7 100	6 000	8 900	7 200	6 000	8 600	7 100	5 900	6 500	6 700		
18		6 200		7 400	6 400	5 700	8 300	6 700	5 800	8 500	6 900	5 800	8 200	6 800	5 700	6 400	6 500	5 600	
20				6 900	6 100	5 500	7 800	6 400	5 600	8 000	6 600	5 600	7 900	6 600	5 600	6 400	6 300	5 400	
22				6 400	5 900	5 400	7 300	6 200	5 400	7 600	6 300	5 400	7 500	6 300	5 400	6 400	6 100	5 300	
24				6 200	5 900		6 800	6 000	5 300	7 200	6 100	5 300	7 200	6 100	5 300	6 300	6 000	5 200	
26							6 500	5 800	5 200	6 900	5 900	5 200	6 900	5 900	5 200	6 300	5 800	5 100	
28							6 100	5 700	5 200	6 600	5 700	5 100	6 600	5 800	5 000	6 200	5 600	5 000	
30							5 800	5 600		6 300	5 600	5 000	6 400	5 600	4 900	6 100	5 500	4 900	
32							5 700	5 400		5 900	5 500	4 900	6 200	5 500	4 900	6 000	5 300	4 800	
34										5 600	5 400	4 900	5 900	5 400	4 800	5 800	5 200	4 700	
36										5 200	5 200		5 700	5 300	4 700	5 600	5 100	4 600	
38										4 900	4 900		5 400	5 200	4 700	5 400	5 000	4 600	
40										4 800	4 700		5 100	5 100	4 700	4 900	4 900	4 600	
42													4 800	4 800	4 700	4 300	4 600	4 500	
44													4 500	4 600		3 800	4 100	4 200	
46													4 200	4 200		3 400	3 600	3 600	
48													3 800	3 800		3 000	3 200	3 200	
50													3 600			2 600	2 800	2 800	
52																2 200	2 400		
54																2 000	2 000		
56																1 700	1 700		
58																1 600			

THIS CHART IS ONLY A GUIDE AND SHOULD NOT BE USED TO OPERATE THE CRANE.
The individual crane's load chart, operating instructions and other instructional plates must be read and understood prior to operating the crane.

Working range

Extensions - metric 75%

Main boom with extensions

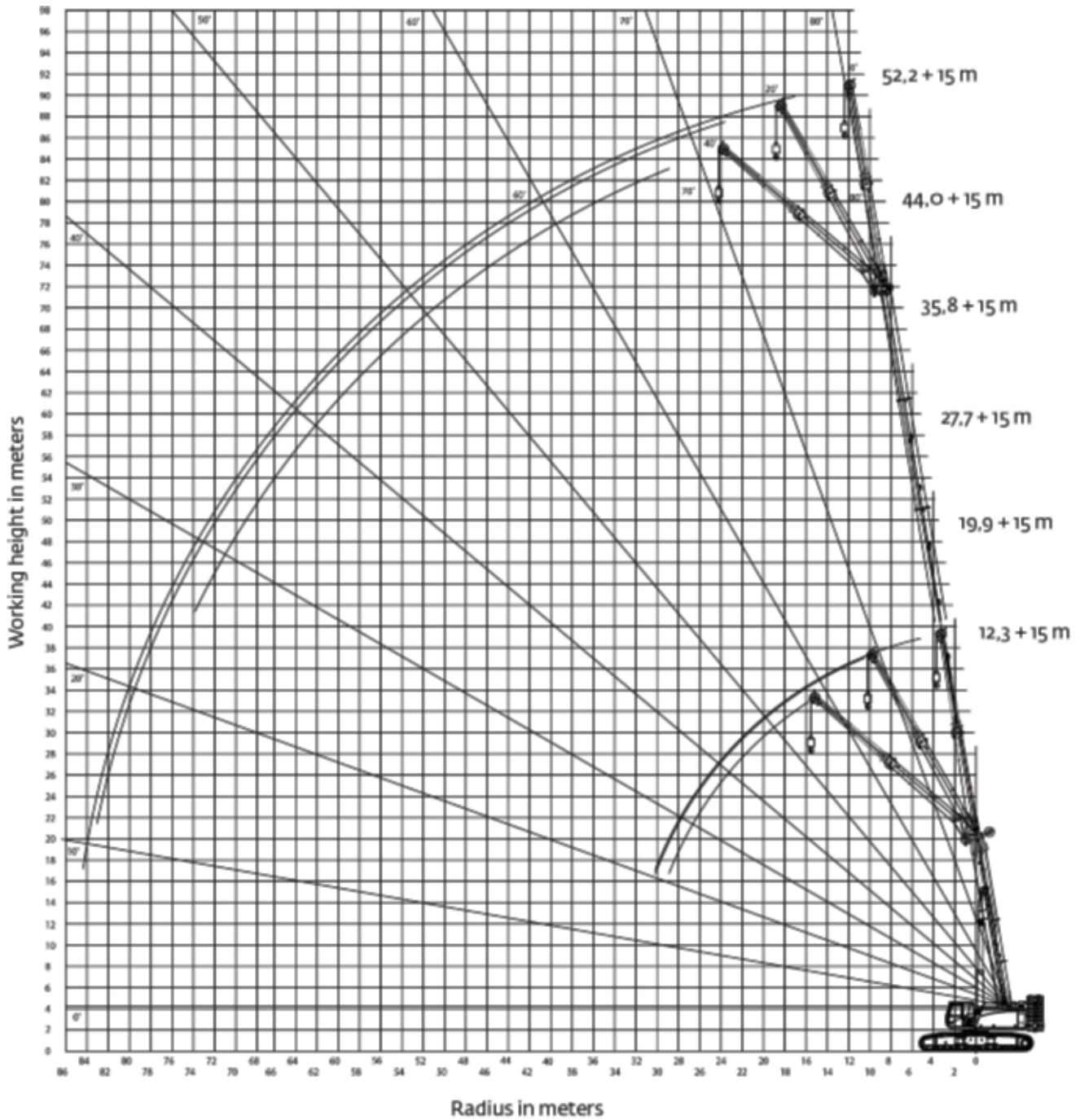

*THIS CHART IS ONLY A GUIDE AND SHOULD NOT BE USED TO OPERATE THE CRANE.
The individual crane's load chart, operating instructions and other instructional plates must be read and understood prior to operating the crane.*

Load chart

Extensions - metric 75%



52,2 m



15 m



35 t



100%



360°



0.3°



Kilograms

Radius [m]	Main boom length [m]																		
	12,3			19,9			27,7			35,8			44,0			52,2			
	0°	20°	40°	0°	20°	40°	0°	20°	40°	0°	20°	40°	0°	20°	40°	0°	20°	40°	
5	5 800																		
6	5 500			5 400															
7	5 200			5 300			4 900												
8	4 900	3 800		5 200			4 800												
9	4 600	3 700		5 000			4 700			4 400									
10	4 300	3 500		4 800			4 600			4 300			4 000						
12	3 800	3 200	2 600	4 400	3 400		4 500	3 400		4 200			3 900						
14	3 400	3 000	2 500	4 000	3 200		4 200	3 200		4 100	3 200		3 800				3 000		
16	3 100	2 800	2 400	3 700	3 000	2 500	3 900	3 000	2 500	3 900	3 100		3 700	3 100			3 000		
18	2 900	2 600	2 300	3 400	2 800	2 400	3 600	2 900	2 400	3 800	2 900	2 400	3 600	2 900			3 000	2 900	
20	2 700	2 500	2 200	3 100	2 700	2 400	3 400	2 700	2 400	3 600	2 800	2 400	3 500	2 800	2 400		3 000	2 800	
22	2 500	2 400	2 200	2 900	2 600	2 300	3 200	2 600	2 300	3 400	2 700	2 300	3 400	2 700	2 300		3 000	2 700	2 300
24	2 400	2 300		2 700	2 400	2 200	3 000	2 500	2 200	3 200	2 600	2 300	3 300	2 600	2 300		3 000	2 600	2 200
26				2 500	2 300	2 200	2 800	2 400	2 200	3 000	2 500	2 200	3 100	2 500	2 200		3 000	2 500	2 200
28				2 400	2 300	2 200	2 700	2 300	2 200	2 900	2 400	2 200	3 000	2 500	2 200		2 900	2 500	2 200
30				2 300	2 200	2 200	2 500	2 300	2 100	2 700	2 300	2 100	2 900	2 400	2 100		2 800	2 400	2 100
32				2 200	2 200		2 400	2 200	2 100	2 600	2 300	2 100	2 700	2 300	2 100		2 800	2 300	2 100
34							2 300	2 200	2 100	2 500	2 200	2 100	2 600	2 300	2 100		2 700	2 300	2 000
36							2 200	2 100		2 400	2 200	2 100	2 500	2 200	2 100		2 600	2 200	2 000
38							2 200	2 100		2 300	2 100	2 100	2 500	2 200	2 000		2 500	2 200	2 000
40										2 200	2 100	2 100	2 400	2 100	2 000		2 400	2 100	2 000
42										2 200	2 100		2 300	2 100	2 000		2 300	2 100	2 000
44										2 100	2 100		2 200	2 000	2 000		2 300	2 000	1 900
46										2 100	2 100		2 200	2 000	2 000		2 200	2 000	1 900
48													2 100	2 000	2 000		2 100	2 000	1 900
50													2 000	2 000			2 100	1 900	1 900
52													2 000	2 000			2 000	1 900	1 900
54													2 000	2 000			2 000	1 900	1 900
56																	1 900	1 900	1 900
58																	1 800	1 900	
60																	1 600	1 600	
62																	1 300	1 400	
64																	1 100	1 300	

*THIS CHART IS ONLY A GUIDE AND SHOULD NOT BE USED TO OPERATE THE CRANE.
The individual crane's load chart, operating instructions and other instructional plates must be read and understood prior to operating the crane.*

Working range

Main boom - imperial 75%

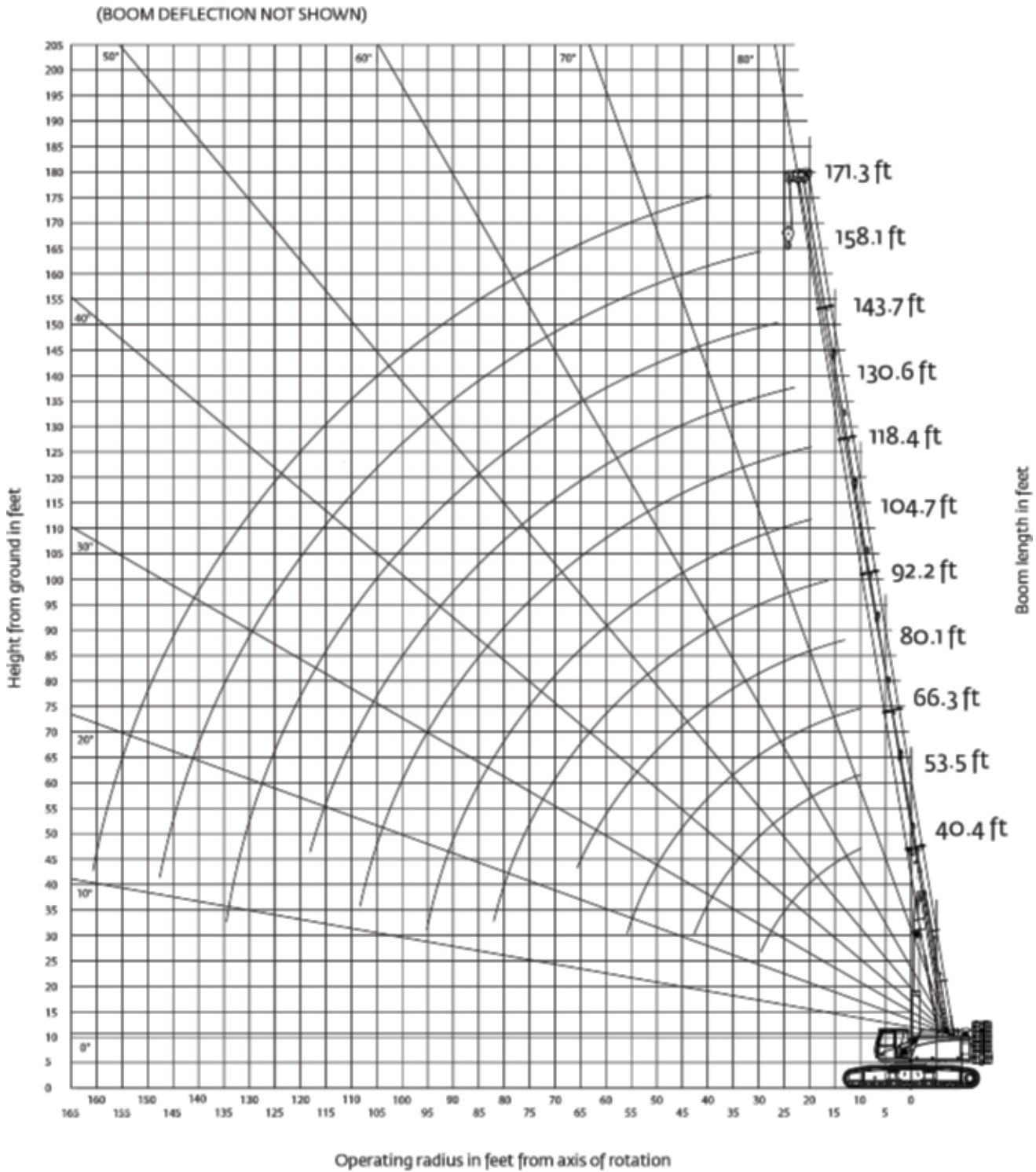

*THIS CHART IS ONLY A GUIDE AND SHOULD NOT BE USED TO OPERATE THE CRANE.
The individual crane's load chart, operating instructions and other instructional plates must be read and understood prior to operating the crane.*

Load chart

Main boom - imperial 75%



171.3 ft



77,836 lb



100%



360°



0.3°



Pounds

Radius [ft]	Main boom length [ft]											
	40.4	52.5	65.6	78.7	91.9	105.0	118.1	131.2	144.4	157.5	171.3	
10	278,300*											
15	218,200*	175,900	164,600									
20	160,600	162,500	146,100	135,400	109,000							
25	124,400	148,600	131,600	122,800	107,600	100,600	76,700					
30		125,800	119,300	110,000	102,300	89,900	70,000	53,700				
35		102,500	104,100	100,100	93,800	85,300	64,600	50,100	40,900	31,900		
40		85,100	87,600	87,500	83,700	78,600	59,800	44,800	39,200	31,600		
45		68,700	73,500	74,000	73,300	71,200	55,500	41,600	36,300	31,300	26,000	
50		53,500	62,300	62,500	61,900	58,600	51,500	39,100	33,900	30,900	25,400	
55			53,500	53,700	53,200	50,100	48,200	36,500	32,000	29,900	25,100	
60				46,600	46,100	42,900	43,900	34,400	29,900	28,600	24,700	
65				40,800	40,300	36,800	38,400	32,800	27,800	27,300	24,400	
70				36,300	35,600	33,500	33,800	31,100	26,200	26,000	24,100	
75					32,000	30,100	30,000	29,400	25,000	24,500	23,400	
80					28,700	26,800	26,700	27,700	23,800	23,100	22,600	
85						23,600	24,000	26,000	22,700	21,800	21,600	
90						21,100	22,100	24,400	21,600	21,000	20,600	
95						19,400	21,100	21,900	20,700	20,100	19,600	
100							20,300	19,900	19,800	19,100	18,400	
105							19,100	18,300	18,600	18,100	17,200	
110								17,000	16,500	16,800	15,600	
115								15,600	15,700	15,400	14,300	
120								14,500	14,900	14,200	13,100	
125									13,900	13,100	11,900	
130									12,700	12,100	10,700	
135									11,900	11,100	9,700	
140										9,900	8,800	
145										9,000	8,000	
150											7,200	
155											6,500	
160											5,700	

* Valid with special equipment

*THIS CHART IS ONLY A GUIDE AND SHOULD NOT BE USED TO OPERATE THE CRANE.
The individual crane's load chart, operating instructions and other instructional plates must be read and understood prior to operating the crane.*

Load chart

Main boom - imperial 75%



171.3 ft



77,836 lb



100%



360°



1.5°



Pounds

Radius [ft]	Main boom length [ft]										
	40.4	52.5	65.6	78.7	91.9	105.0	118.1	131.2	144.4	157.5	171.3
10	186,900	141,100	119,400								
15	170,100	141,100	125,700	110,200	96,400						
20	152,600	139,800	125,700	109,800	99,000	77,200	67,100				
25	124,400	122,300	119,300	105,100	95,600	77,200	64,800	42,300			
30		102,500	104,100	100,100	89,800	76,800	61,400	40,700	33,700	24,300	
35		85,100	87,600	87,500	82,200	73,500	58,100	39,900	33,400	24,300	
40		68,700	73,500	74,000	73,300	69,200	54,900	38,800	32,600	24,300	19,800
45		53,500	62,300	62,500	61,900	58,300	51,400	36,800	32,100	24,300	19,800
50			53,500	53,700	53,200	50,100	47,300	34,700	30,900	24,300	19,800
55				46,600	46,100	42,900	42,900	32,800	29,400	24,300	19,800
60				40,800	40,300	36,800	38,400	31,000	27,800	24,300	19,800
65				36,300	35,600	33,500	33,800	29,300	26,200	24,300	19,600
70					32,000	30,100	30,000	27,900	25,000	24,000	19,500
75					28,700	26,800	26,700	26,700	23,800	23,100	19,200
80						23,600	24,000	25,500	22,700	21,800	18,900
85						21,100	22,100	24,300	21,600	21,000	18,700
90						19,400	21,100	21,900	20,700	20,100	18,300
95							20,300	19,900	19,800	19,100	17,900
100							19,100	18,300	18,600	18,100	17,200
105								17,000	16,500	16,800	15,600
110								15,600	15,700	15,400	14,300
115								14,500	14,900	14,200	13,100
120									13,900	13,100	11,900
125									12,700	12,100	10,700
130									11,900	11,100	9,700
135										9,900	8,800
140										9,000	8,000
145											7,200
150											6,500
155											5,700

* Valid with special equipment

*THIS CHART IS ONLY A GUIDE AND SHOULD NOT BE USED TO OPERATE THE CRANE.
The individual crane's load chart, operating instructions and other instructional plates must be read and understood prior to operating the crane.*

Load chart

Auxiliary boom nose - imperial 75%



171.3 ft



with auxiliary boom nose



77,836 lb



100%



360°



1.5°



Pounds

Radius [ft]	Main boom length [m]										
	40.4	53.1	65.3	77.4	90.9	104.3	117.5	129.9	144.4	157.8	171.3
10	27,600	27,600	27,600								
15	27,600	27,600	27,600	27,600	27,600						
20	27,600	27,600	27,600	27,600	27,600	27,600	27,600				
25	27,600	27,600	27,600	27,600	27,600	27,600	27,600	27,600			
30		27,600	27,600	27,600	27,600	27,600	27,600	27,600	27,600	24,300	
35		27,600	27,600	27,600	27,600	27,600	27,600	27,600	27,600	24,300	
40		27,600	27,600	27,600	27,600	27,600	27,600	27,600	27,600	24,300	19,800
45		27,600	27,600	27,600	27,600	27,600	27,600	27,600	27,600	24,300	19,800
50			27,600	27,600	27,600	27,600	27,600	27,600	27,600	24,300	19,800
55			27,600	27,600	27,600	27,600	27,600	27,600	27,600	24,300	19,800
60				27,600	27,600	27,600	27,600	27,600	27,400	24,300	19,800
65				27,600	27,600	27,600	27,600	27,600	26,300	24,300	19,600
70				27,600	27,600	27,600	27,600	27,500	24,800	24,100	19,400
75					28,600	26,600	26,600	26,600	23,800	22,700	19,200
80					25,800	23,400	23,900	25,500	22,700	21,900	18,900
85						21,000	22,100	24,300	21,600	21,000	18,700
90						19,400	21,100	21,600	20,700	20,100	18,200
95						17,700	20,300	19,900	19,800	19,200	17,900
100							19,000	18,200	18,900	18,300	17,200
105							17,200	17,000	16,500	16,800	15,600
110							6,600	15,500	15,500	15,400	14,300
115								14,200	15,000	14,100	13,000
120								13,200	13,800	13,100	11,800
125									12,700	12,100	10,700
130									11,900	11,100	9,700
135										10,000	8,600
140										9,100	7,900
145										8,500	7,200
150											6,500
155											5,600
160											5,100

THIS CHART IS ONLY A GUIDE AND SHOULD NOT BE USED TO OPERATE THE CRANE.
The individual crane's load chart, operating instructions and other instructional plates must be read and understood prior to operating the crane.

Working range

Extensions - imperial 75%

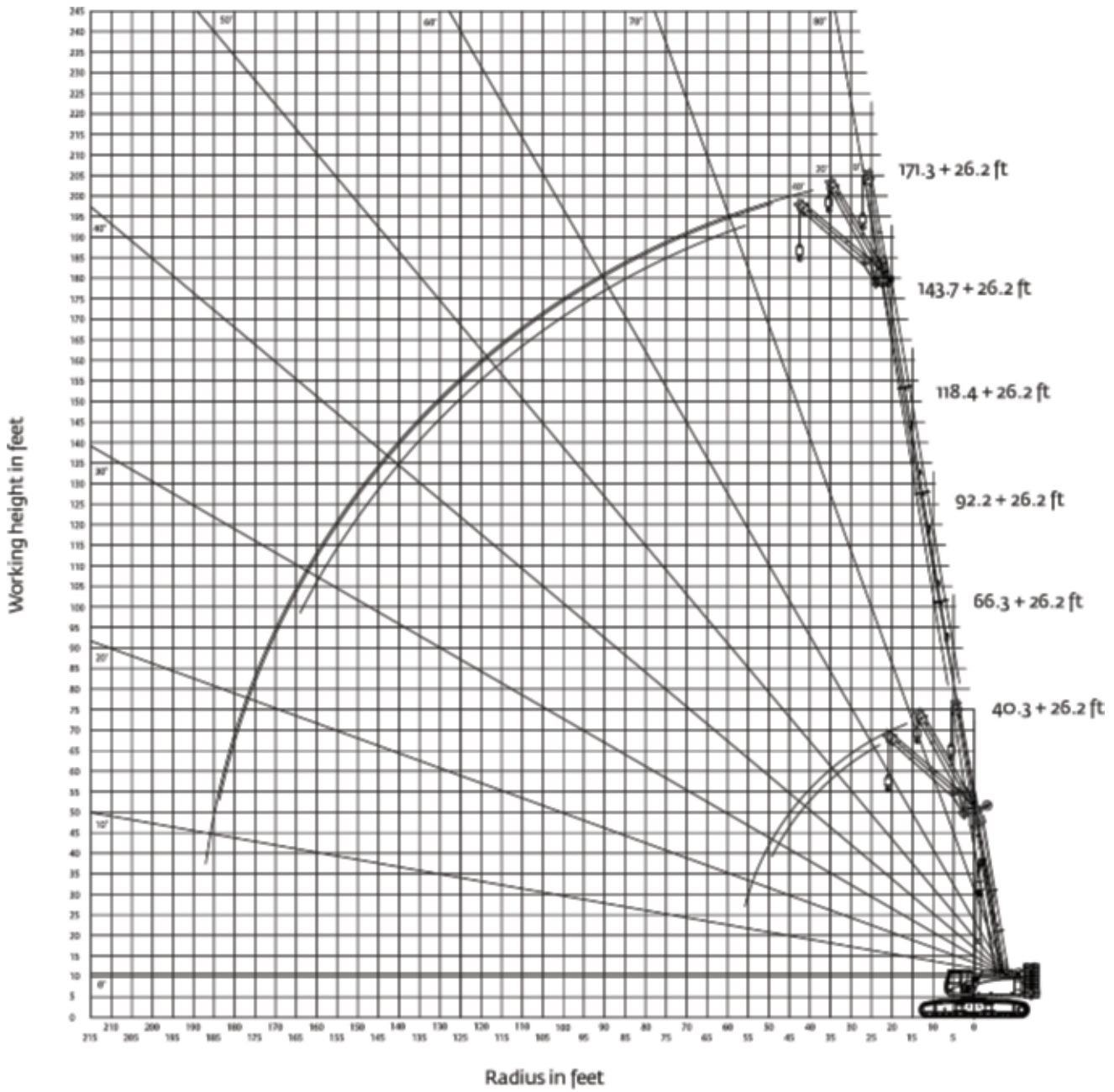

*THIS CHART IS ONLY A GUIDE AND SHOULD NOT BE USED TO OPERATE THE CRANE.
The individual crane's load chart, operating instructions and other instructional plates must be read and understood prior to operating the crane.*

Load chart

Extensions - imperial 75%



171.3 ft



26.3 ft



77,836 lb



100%



360°



0.3°



Pounds

Radius [ft]	Main boom length [ft]																	
	40.4			65.3			90.9			117.5			144.4			171.3		
	0°	20°	40°	0°	20°	40°	0°	20°	40°	0°	20°	40°	0°	20°	40°	0°	20°	40°
20	28,300	21,100		30,600	21,700		29,400											
25	24,900	19,200	15,500	27,700	20,300		27,400			24,900								
30	22,200	17,600	14,700	25,300	19,000	15,100	25,600	19,200		24,000								
35	19,900	16,300	14,000	23,300	17,900	14,600	24,000	18,300	14,600	23,000	18,000		20,800					
40	17,900	15,200	13,400	21,600	16,900	14,000	22,500	17,500	14,200	22,000	17,400	14,000	20,300			14,300		
45	16,200	14,400	12,900	20,100	16,000	13,600	21,300	16,700	13,700	21,000	16,700	13,700	19,800			14,300		
50	14,800	13,700		18,700	15,200	13,100	20,200	16,000	13,300	20,100	16,100	13,300	19,200	15,900	13,100	14,300		
55				17,400	14,600	12,800	19,100	15,300	13,000	19,300	15,600	13,000	18,600	15,400	12,800	14,200	14,700	
60				16,200	14,000	12,400	18,200	14,800	12,700	18,500	15,100	12,700	18,000	15,000	12,600	14,200	14,300	12,200
65				15,300	13,500	12,200	17,300	14,300	12,400	17,800	14,600	12,400	17,500	14,600	12,300	14,100	14,000	12,000
70				14,400	13,200		16,400	13,800	12,100	17,000	14,100	12,100	16,900	14,200	12,100	14,100	13,700	11,800
75					13,000		15,600	13,400	11,800	16,400	13,700	11,900	16,300	13,800	11,800	14,000	13,400	11,600
80							14,900	13,100	11,600	15,800	13,400	11,600	15,800	13,400	11,600	13,900	13,100	11,400
85							14,300	12,800	11,500	15,200	13,100	11,400	15,300	13,100	11,400	13,800	12,800	11,200
90							13,700	12,600		14,700	12,800	11,300	14,800	12,800	11,200	13,700	12,500	11,000
95							13,200	12,400		14,200	12,500	11,100	14,400	12,600	11,000	13,600	12,300	10,800
100								12,200		13,600	12,300	11,000	13,900	12,300	10,900	13,400	12,000	10,700
105										13,100	12,100	10,900	13,600	12,100	10,700	13,100	11,800	10,500
110										12,400	11,900	10,900	13,200	11,900	10,600	12,800	11,600	10,400
115										11,900	11,700		12,800	11,700	10,500	12,500	11,400	10,300
120										11,300	11,300		12,400	11,500	10,400	12,200	11,200	10,200
125											10,800		11,900	11,400	10,400	11,800	11,100	10,100
130											10,400		11,400	11,300	10,400	11,000	10,900	10,000
135													10,900	10,900	10,400	10,000	10,500	10,000
140													10,400	10,400		9,100	9,800	9,700
145													9,900	10,000		8,300	8,900	9,100
150													9,400	9,400		7,600	8,200	8,100
155													8,800	8,700		6,900	7,400	7,400
160																6,300	6,700	6,700
165																5,600	6,100	
170																4,900	5,500	
175																4,600	4,700	
180																4,100	4,100	

THIS CHART IS ONLY A GUIDE AND SHOULD NOT BE USED TO OPERATE THE CRANE.
The individual crane's load chart, operating instructions and other instructional plates must be read and understood prior to operating the crane.

Working range

Extensions - imperial 75%

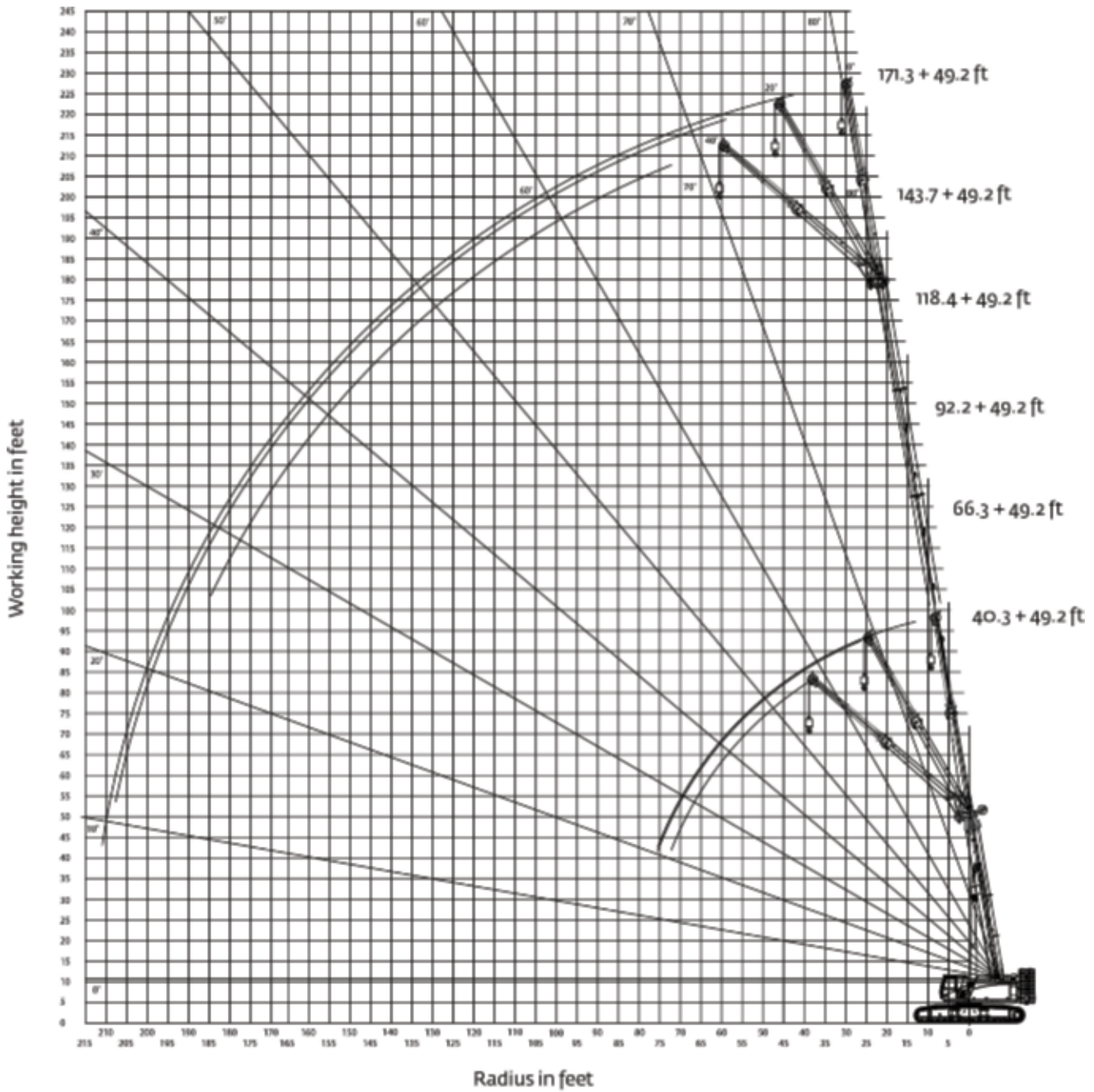

*THIS CHART IS ONLY A GUIDE AND SHOULD NOT BE USED TO OPERATE THE CRANE.
The individual crane's load chart, operating instructions and other instructional plates must be read and understood prior to operating the crane.*

Load chart

Extensions - imperial 75%



171.3 ft



49.3 ft



77,836 lb



100%



360°



0.3°



Pounds

Radius [ft]	Main boom length [ft]																	
	40.4			65.3			90.9			117.5			144.4			171.3		
	0°	20°	40°	0°	20°	40°	0°	20°	40°	0°	20°	40°	0°	20°	40°	0°	20°	40°
20	12,100			11,900														
25	11,000			11,500			10,700											
30	10,000	8,000		11,000			10,400			9,700								
35	9,100	7,500		10,400			10,100			9,500			8,700					
40	8,300	7,000	5,700	9,700	7,500		9,800	7,400		9,300			8,700					
45	7,700	6,600	5,500	9,000	7,100		9,300	7,100		9,000			8,500					
50	7,200	6,300	5,300	8,400	6,800		8,800	6,800		8,800	6,900		8,300			6,600		
55	6,700	5,900	5,200	7,800	6,500	5,500	8,300	6,500	5,500	8,500	6,600		8,200	6,600		6,600		
60	6,300	5,700	5,000	7,400	6,200	5,400	7,900	6,300	5,300	8,200	6,400	5,400	8,000	6,400		6,600	6,300	
65	5,900	5,500	4,900	6,900	5,900	5,200	7,500	6,100	5,200	7,900	6,200	5,200	7,800	6,200		6,600	6,200	
70	5,600	5,300	4,900	6,600	5,700	5,100	7,100	5,900	5,100	7,500	6,000	5,100	7,600	6,100	5,100	6,600	6,000	
75				6,200	5,500	5,000	6,800	5,700	5,000	7,200	5,800	5,000	7,400	5,900	5,000	6,600	5,900	5,000
80				5,900	5,300	4,900	6,500	5,500	4,900	6,900	5,700	5,000	7,200	5,800	5,000	6,600	5,700	4,900
85				5,600	5,200	4,900	6,200	5,400	4,900	6,700	5,500	4,900	6,900	5,600	4,900	6,600	5,600	4,800
90				5,400	5,100	4,900	6,000	5,200	4,800	6,400	5,400	4,800	6,700	5,500	4,800	6,500	5,500	4,800
95				5,200	5,000		5,700	5,100	4,800	6,200	5,300	4,800	6,500	5,400	4,800	6,300	5,300	4,700
100					4,900		5,500	5,000	4,700	6,000	5,100	4,700	6,300	5,200	4,700	6,200	5,200	4,600
105							5,400	4,900	4,600	5,800	5,000	4,700	6,100	5,100	4,600	6,100	5,100	4,600
110							5,200	4,800	4,600	5,600	4,900	4,600	5,900	5,000	4,600	5,900	5,000	4,500
115							5,000	4,700		5,400	4,800	4,600	5,700	4,900	4,500	5,800	4,900	4,500
120								4,700		5,300	4,800	4,600	5,500	4,800	4,500	5,600	4,800	4,400
125										5,100	4,700	4,600	5,400	4,800	4,500	5,500	4,800	4,400
130										5,000	4,600	4,600	5,300	4,700	4,500	5,400	4,700	4,400
135										4,900	4,600		5,100	4,600	4,400	5,200	4,600	4,300
140										4,800	4,600		5,000	4,600	4,400	5,100	4,500	4,300
145										4,700	4,500		4,900	4,500	4,400	5,000	4,500	4,200
150										4,600	4,600		4,800	4,400	4,500	4,900	4,400	4,200
155													4,700	4,400	4,500	4,800	4,400	4,200
160													4,600	4,400		4,700	4,300	4,200
165													4,500	4,400		4,600	4,200	4,200
170													4,400	4,400		4,500	4,200	4,200
175													4,400	4,400		4,400	4,200	4,200
180																4,300	4,200	4,200
185																4,200	4,200	
190																4,000	4,200	
195																3,700	3,700	
200																3,200	3,300	
205																2,800		

THIS CHART IS ONLY A GUIDE AND SHOULD NOT BE USED TO OPERATE THE CRANE.
The individual crane's load chart, operating instructions and other instructional plates must be read and understood prior to operating the crane.

Load handling

8 m - 15 m (26.2 ft - 49.2 ft) : Boom extension:		
	Without block or ball	With 350 kg (770 lb) headache ball
*8 m (26.2 ft) extension (erected)	1063 kg (2344 lb)	1879 kg (4143 lb)
*15 m (49.2 ft) extension (erected)	1688 kg (3721 lb)	2504 kg (5520 lb)
Hook blocks and Headache ball:		

*Reduction of main boom capacities
+Refer to rating plate for actual weight

When lifting over boom extension, deduct total weight of all load handling devices reeved over main boom nose from boom extension capacity.

NOTE: All load handling devices and boom attachments are considered part of the load and suitable allowances **MUST BE MADE** for their combined weights. Weights are for Grove furnished equipment.

Line pulls and reeving information			
Hoists	Cable specs	Permissible line pulls	Nominal cable length
Main and auxiliary	26 mm Verotop Rotation Resistant (non-rotating) Min. breaking strength 65 800 kg (145,000 lb)	12 500 kg* (27,600 lb*)	210 m (689 ft)
Main and auxiliary	26 mm Casar Starlift (35x7 class) Rotation Resistant Min. breaking strength 62 685 kg (138,200 lb)	12 500 kg* (27,600 lb*)	210 m (689 ft)

The approximate weight of Verotop and Casar 26 mm wire rope is 3,3 kg/m (2.2 lb/ft).

*With certain boom and hoist tackle combinations, the allowable line pull may be limited by hoist performance. Refer to Hoist Performance table for lift planning to ensure adequate hoist performance on drum rope layer required.

Hoist performance				
Wire rope layer	Hoist line pulls two-speed hoist		Drum rope capacity	
	Low available*	High available*	Layer	Total
1	18 365 kg (40,488 lb)	5874 kg (12,949 lb)	21,9 m (71.8 ft)	21,9 m (71.8 ft)
2	16 891 kg (37,238 lb)	5402 kg (11,910 lb)	23,9 m (78.1 ft)	45,7 m (149.9 ft)
3	15 636 kg (34,471 lb)	5001 kg (11,025 lb)	25,7 m (84.3 ft)	71,4 m (234.2 ft)
4	14 554 kg (32,087 lb)	4655 kg (10,262 lb)	27,6 m (90.6 ft)	99,0 m (324.8 ft)
5	13 613 kg (30,012 lb)	4354 kg (9598 lb)	29,5 m (96.9 ft)	128,5 m (421.7 ft)
6	12 786 kg (28,188 lb)	4089 kg (9015 lb)	31,4 m (103.1 ft)	160,0 m (524.8 ft)
7	12 053 kg (26,573 lb)	3855 kg (8499 lb)	33,3 m (109.4 ft)	193,3 m (634.2 ft)

*Max lifting capacity: Verotop & 35x7 class rope = 12 500 kg (27,600 lb)

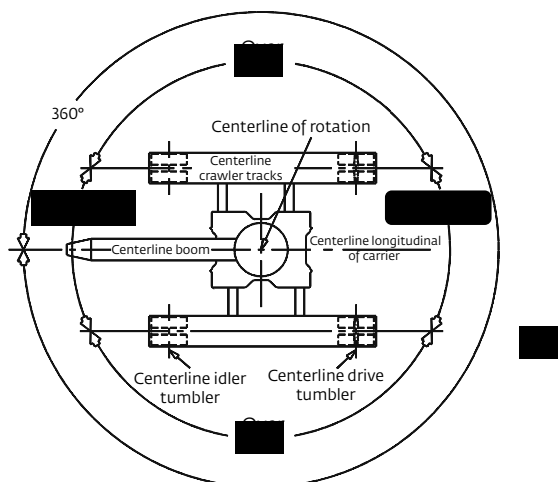

*THIS CHART IS ONLY A GUIDE AND SHOULD NOT BE USED TO OPERATE THE CRANE.
The individual crane's load chart, operating instructions and other instructional plates must be read and understood prior to operating the crane.*

Specifications



Standard Boom

12,3 m - 52,2 m (40.4 ft - 171.3 ft) six-section telescopic pin boom.

Maximum tip height: 55 m (181 ft)



Boom extension

15 m (49.3 ft) offsettable bi-fold swingaway extension. Extension can be offset at 0°, 20° and 40°.

Maximum tip height: 70 m (229.7 ft)



Heavy duty jib extension

3 m (10 ft) heavy duty jib extension that is offset at 10°. Stowable on left side of boom.



Boom nose

Five nylatron sheaves on heavy-duty roller bearings with removable rope guards. Quick reeve type boom nose.

Equipped with removable auxiliary boom nose.



Boom elevation

One double-acting hydraulic cylinder with integral holding valves. Elevation: -4.9° to 80.0°.



Counterweight

35 300 kg (77,836 lbs.) total (7 pieces). Hydraulically installed and removed.



Rated Capacity Limiter and anti-two block system

Graphical display of load moment and anti-two block system with audio-visual warning and control lever lockout. These systems provide electronic display of crane configuration, boom angle, length, radius, tip height, maximum permissible load, momentary load and warning of impending two-block condition. Includes advanced diagnostics system that increases the performance of the machine, simplifies and accelerates troubleshooting, and lowers operating costs. Equipped with event recorder.



Cab

Large-capacity operator's compartment that includes an air suspended operator's seat with lumbar support, heated seat, headrest, 3" safety belt, ergonomic control panels, load sensing electric dual axis joystick controls, travel pedals and levers, exceptional sound insulation, sliding door (includes sliding window), excellent all around visibility, tinted safety glass, front tiltable window, large skylight w/ sun protection, windshield and roof wiper/washer system, Bluetooth/AM/FM/USB/MP3 radio, climate control (A/C, heat, and defrost), fire extinguisher, and 20° tilt capability for improved overhead vision and ergonomic posture. Also equipped with a 7" monitor in cab for rear view, right side and hoist cameras.



Swing

Two-speed, compact planetary gear with axial piston hydraulic motor and integrated brake valves. Sealed, externally geared slewing ring that allows for 360° of continuous rotation. Electronically applied service brake operated via foot pedal. Spring applied, hydraulically released parking brake. Two position, hydraulically pinned house lock.

Swing speed: 0-2 rpm, variable



Hydraulic system

Load sensing / LUDV hydraulic system with hydraulic and pilot-controlled work functions, and load limit sensing control. Single variable-displacement piston pump with a three-section gear pump.

Maximum output: 500 lpm (132 gpm)

Maximum operating pressure: 330 bar (4786 psi)

900 L (238 gal) steel hydraulic reservoir with sight level gauge.

High performance, 3-micron filtration system with water absorption contamination indicator for higher oil purity and extended oil service life.



Hoist

Two-speed hoists driven via an axial piston hydraulic motor with compact planetary gear. Spring-loaded disc brake. Grooved drum with drum rotation indicator for both hoists that is located in the joystick controls.

Maximum hoist pull (first layer): 18 365 kg (40,488 lb)

Maximum permissible single line pull: 12 500 kg (27,558 lb)

Maximum single line speed: 115 m/min (377 ft/min)

Rope construction: 35 X 7 Rotation Resistant

Rope diameter: 26 mm

Rope length: 210 m (688 ft)



Engine (Tier 4)

Cummins QSB 6.7 L diesel, six cylinders, turbocharged with Cummins Diesel Oxidation (DOC) Catalyst and Selective Catalytic Reduction (SCR).

Meets USEPA Tier 4 final requirements.

186kW (249 bhp) at 2000 rpm.

Fuel requirements: Maximum of 15 ppm sulphur content (ultra-low diesel fuel). DEF (diesel exhaust fluid) required for SCR (selective catalytic reduction).

Specifications



Engine (Tier 3)

Cummins QSB 6,7 L diesel, six cylinders, turbocharged rated at 164 kW (220 bhp) at 2000 rpm.



Fuel tank capacity

Diesel Fuel: 450 L (119 gal)
DEF (Diesel Exhaust Fluid): 45 L (12 gal)



Electrical system

24 volt with two 12-volt, maintenance-free batteries. Includes battery disconnect switch.



Lights

Lighting package includes two halogen lights integrated into the front side of the cab roof and one LED headlight on the upper carriage, right side.



Cameras

Back-up, right-side and hoist cameras.

Lower carriage



Frame

Durable all steel welded construction with extendable side frame beams and hydraulic jacks for side frame installation and removal. Frame mounted hydraulic jacks also used for track extension and retraction.



Side frames

Four steel side frame beams that can be hydraulically extended or retracted via controls in the cab. 900 mm (36 in) triple bar maintenance-free track shoes.

Retracted gauge: 3,1 m (10.0 ft)

Intermediate gauge: 4,2 m (13.8 ft)

Extended gauge: 5,4 m (17.7 ft)

*NOTE: These widths are from centerline to centerline of crawlers.



Travel

Two-speed hydrostatic drive operated via lever/pedal controls in cab. Allows for excellent maneuverability with skid steering and counter-rotation. Both side frames are hydraulically driven through a two-stage hydraulic traction motor. Spring-loaded, hydraulically release multi-disk brake.

Travel Speed: Max Low Range – 0,80 kmh (0.50 mph)

Max High Range – 2,49 kmh (1.55 mph)

Gradeability (theoretical): 57%

Operating weight

119 295 kg (263,000 lb) base machine configuration that includes 52,1 m (171 ft) boom, 15 m (49.3 ft) extension, 80 t (88 USt) hook block, 900 mm (36 in) triple bar crawlers, main and auxiliary hoist, and 35 300 kg (77,836 lb) counterweight. Ground bearing pressure (no load): 0,96 kg/cm² (13.9 psi)

Miscellaneous standard equipment

- Central, easily accessible lubricating strip.
- Grated platform in front of cab, and foldable grated platforms on side of cab and both sides of the upper carriage. Foldable handrails included for upper carriage.
- Service friendly engine and hydraulic compartment with decoupled engine suspension, sound proofing and lighting.
- 80 t (88 USt) 3-sheave quick reeve hook block.
- External RCL light bar.
- Storage box attached to crawler side frame.

*Optional equipment

- Basket: Yoke style, 72 in x 36 in (1829 mm x 914 mm) steel basket, gravity hung with cylinder brake lock (does not side stow). Includes quick-attach boom attachment. Basket capacities: 544,3 kg (1200 lb) main boom and 226,7 kg (500 lb) on boom extension.
- Radio remote control package.
- Cold weather packages up to -40° C / 40° F.
- Maintenance-free flat track shoes.
- Polyurethane clamp-on track pads.
- Two additional LED lights mounted on base boom
- Wind speed indicator (hardwired) displayed thru RCL.
- Work area definition system.
- Swing barrier protection. Provides a swing perimeter when used with caution tape.
- Pinion lubrication for slewing gear with lubrication pump, operated from cab, with special lubricant.
- CraneStar asset management system.

Symbols glossary

 Boom	 Counterweight	 Hydraulic system	 Side frames
 Boom elevation	 Electrical system	 Incline	 Swing
 Boom extension	 Engine	 Jib extension	 Track span
 Boom length	 Frame	 Lights	 Travel
 Boom nose	 Fuel tank capacity	 Radius	
 Cab	 Heavy duty jib	 Rated capacity limiter / anti-two block system	
 Camera	 Hoist	 Rotation	

Notes

Notes

Manitowoc Cranes

Americas

Europe, Middle East, Africa

China

Middle East and
Greater Asia-Pacific

Manitowoc
Crane Care™



Manitowoc
Finance™

