

2501-MT



MAXIMUM LIFTING CAPACITY: 20,000 lbs
EXTENDED LENGTH: 52.23'

Non CDL Truck mount available
Known World Wide, TADANO Quality in North America

TM-1052 (10 ton) crane specifications

MAXIMUM LIFTING CAPACITY

20,000 lbs. @ 5' (6-part lines) / 14,000lbs@5' (6part lines : Derated chart)

13,200 lbs. @ 6' (4-part lines)

6,600 lbs. @ 16' (2-part lines)

BOOM

5-sectioned, fully powered partly synchronized telescoping boom of pentagonal box construction

Retracted length	14.44'
Extended length	52.23'
Extended speed	37.79' / approx. 43 s
Elevation	Elevated by double-acting hydraulic cylinder
Elevation speed	1° to 82° / approx. 19 s

NOTE: Extended speed and elevation speed are calculated under the condition that the flow is 15.8 GPM

Boom point 3 sheaves

WINCH

Hydraulic motor driven, planetary gear speed reduction, provided with automatic brake and cable follower

Single line pull	3,340 lbs.
Single line speed	approx. 147FPM (@ 4th layer)

NOTE: Single line speed is calculated under the condition that the flow is 15.8 GPM

Wire rope

Diameter x length	13/32"(10mm) x 312'
Breaking strength	16,530 lbs.

Hook block 3 sheaves (For maximum lifting load)

SWING

Hydraulic motor driven, Worm gear speed reduction, Continuous 360o full circle swing on ball bearing slew ring, Automatic swing lock

Swing speed approx. 2.5 rpm

OUTRIGGERS

<CAB BACK MOUNTED>

Outriggers (Out & Down type)

Hydraulically extended sliders and hydraulically extended jacks, integral with crane frame

Extend width	Min. 7' 4-9/16"
	Mid. 10' 9-29/32"
	Max. 14' 1-9/32"

Rear stabilizers (Straight Down type)

Hydraulically extended jacks, integral with chassis frame

Span 7' 4-19/32"

<REAR MOUNTED>

Rear outriggers (Out & Down type)

Hydraulically extended sliders and hydraulically extended jacks, integral with crane frame

Extend width	Min. 7' 4-9/16"
	Mid. 10' 9-29/32"
	Max. 14' 1-9/32"

<CAB BACK MOUNTED>

Extension Mark for Cab Back Mout

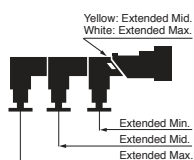

Outriggers Max.

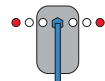

Outriggers Min.

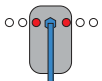

Outriggers Mid.

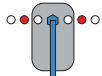

<REAR MOUNTED>

Extension Mark for Rear Mout

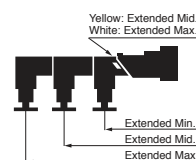

Outriggers Max.

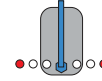

Outriggers Min.

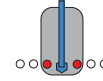

Outriggers Mid.

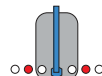

HYDRAULIC

Hydraulic motor	Axial piston type for winch and swing
Control valves	Multiple control valves with integral safety valve
Recommended Hydraulic pump	Pressure : Max. 3,000 PSI capacity Delivery : Max. 15.8 GPM (60L/min)
Reserve tank	24 Gallons capacity *PTO/Mounting not included

ELECTRICAL SYSTEM

Power supply	DC12V
--------------	-------

SAFETY DEVICE

- Anti-two block with alarm
 - Hook safety latch
 - Level gauge
 - Hydraulic safety valves, check valves and holding valves
 - Over load alert with load indicator (TADANO's exclusive "AMA" system)
 - Load indication
 - Load moment ratio to rated load indication
 - Audible warning
 - External warning lamps
-

BOOM REST

No required

LOCALLY PROVIDED EQUIPMENT

- Crane mounting parts (Include P.T.O, P.T.O Mounting, Pump)
 - Hydraulic pump
-

CRANE WEIGHT

Approx. 6,900 lbs. (crane bare)

OPTIONS AND ACCESSORIES

+Radio Remote Controls

Model: RCS-F (Approved by FCC / IC)

Control functions of boom telescoping, hoisting up and down, boom elevating, swing, acceleration, speed mode selection, emergency stop, engine start and vehicle horn

Frequency 40 frequencies in 429 MHz band

Operating power supply

Transmitter 6V DC, Dry battery (AA) x 4

Control unit 12V DC, Vehicle battery

Transmitter weight Approx. 1.26 lbs. (includes batteries)

+One person basket (Radio Remote Controls required, D & F chart only)



TM-1052 (10 ton) crane capacity

RATED LIFTING CAPACITY (IN POUNDS)

CAPACITY CHART; A

Load radius (ft.)	14.4 ft. Boom				23.9 ft. Boom				33.3 ft. Boom				42.8 ft. Boom				52.2 ft. Boom			
	Loaded Boom Angle	Outriggers Extended		Loaded Boom Angle	Outriggers Extended		Loaded Boom Angle	Outriggers Extended Max.	Loaded Boom Angle	Outriggers Extended Max.	Loaded Boom Angle	Outriggers Extended Max.	Loaded Boom Angle	Outriggers Extended Max.	Loaded Boom Angle	Outriggers Extended Max.				
		Max.	Min.		Max.	Min.														
5	72°	20,000	8,800	80°	13,200	8,800	82°													
6	68°	17,800	8,650	78°	13,200	8,600	82°	6,600												
8	58°	13,000	5,450	73°	12,950	5,100	79°	6,600	82°	6,600										
10	47°	9,650	3,650	68°	9,250	3,350	75°	6,600	80°	6,600	82°	6,600	82°	5,700						
12	33°	7,000	2,650	62°	6,650	2,350	72°	6,200	77°	6,200	80°	6,200	80°	5,700						
16				50°	3,900	1,250	64°	3,900	72°	3,900	76°	3,900	76°	3,900						
20				34°	2,650	700	56°	2,650	65°	2,650	71°	2,650	71°	2,650						
25							44°	1,700	57°	1,700	65°	1,700	65°	1,700						
30							27°	1,150	48°	1,150	58°	1,150	58°	1,150						
35									38°	900	51°	900	51°	900						
40									22°	700	43°	700	43°	700						
45											33°	550	33°	550						
	1°	5,600	2,050	1°	1,950	400	1°	950	1°	650	1°	400	1°	400						
		(13.6ft.)			(23.1ft.)			(32.5ft.)		(42.0ft.)		(51.4ft.)								

CAPACITY CHART; D (Bigger stability)

Load radius (ft.)	14.4 ft. Boom				23.9 ft. Boom				33.3 ft. Boom				42.8 ft. Boom				52.2 ft. Boom			
	Loaded Boom Angle	Outriggers Extended		Loaded Boom Angle	Outriggers Extended		Loaded Boom Angle	Outriggers Extended		Loaded Boom Angle	Outriggers Extended Max.	Loaded Boom Angle	Outriggers Extended Max.	Loaded Boom Angle	Outriggers Extended Max.					
		Max.	Min.		Max.	Min.		Max.	Min.											
5	72°	20,000	8,800	80°	13,200	8,800	82°	6,600	6,350											
6	68°	17,800	8,800	78°	13,200	8,800	82°	6,600	6,350	82°	6,600									
8	58°	13,000	7,850	73°	13,000	7,850	79°	6,600	5,700	80°	6,600	82°	5,700	82°	5,700					
10	47°	10,550	5,700	68°	10,550	5,700	75°	6,600	4,200	77°	6,600	80°	5,700	80°	5,700					
12	33°	8,900	4,250	62°	8,900	4,200	72°	6,600	2,550	72°	6,600	76°	5,700	76°	5,700					
16				50°	6,600	2,550	64°	6,150	2,550	72°	5,900	76°	5,700	76°	5,700					
20				34°	4,750	1,700	56°	4,750	1,700	65°	4,300	71°	4,300	71°	4,300					
25							44°	3,400	1,100	57°	3,300	65°	3,250	65°	3,250					
30							27°	2,450	600	48°	2,450	58°	2,450	58°	2,450					
35										38°	2,050	51°	2,050	51°	2,050					
40										22°	1,550	43°	1,550	43°	1,550					
45												33°	1,300	33°	1,300					
	1°	7,800	3,500	1°	3,850	1,250	1°	2,200	500	1°	1,450	1°	950	1°	950					
		(13.6ft.)			(23.1ft.)			(32.5ft.)		(42.0ft.)		(51.4ft.)								

CAPACITY CHART; C (Derated)

Load radius (ft.)	14.4 ft. Boom				23.9 ft. Boom				33.3 ft. Boom				42.8 ft. Boom				52.2 ft. Boom			
	Loaded Boom Angle	Outriggers Extended		Loaded Boom Angle	Outriggers Extended		Loaded Boom Angle	Outriggers Extended Max.	Loaded Boom Angle	Outriggers Extended Max.	Loaded Boom Angle	Outriggers Extended Max.	Loaded Boom Angle	Outriggers Extended Max.						
		Max.	Min.		Max.	Min.														
5	72°	14,000	8,800	80°	13,200	8,800	82°													
6	68°	14,000	8,650	78°	13,200	8,600	82°	6,600												
8	58°	13,000	5,450	73°	12,950	5,100	79°	6,600	82°	6,600										
10	47°	9,650	3,650	68°	9,250	3,350	75°	6,600	80°	6,600	82°	5,700	82°	5,700						
12	33°	7,000	2,650	62°	6,650	2,350	72°	6,200	77°	6,200	80°	5,700	80°	5,700						
16				50°	3,900	1,250	64°	3,900	72°	3,900	76°	3,900	76°	3,900						
20				34°	2,650	700	56°	2,650	65°	2,650	71°	2,650	71°	2,650						
25							44°	1,700	57°	1,700	65°	1,700	65°	1,700						
30							27°	1,150	48°	1,150	58°	1,150	58°	1,150						
35									38°	900	51°	900	51°	900						
40									22°	700	43°	700	43°	700						
45											33°	550	33°	550						
	1°	5,600	2,050	1°	1,950	400	1°	950	1°	650	1°	400	1°	400						
		(13.6ft.)			(23.1ft.)			(32.5ft.)		(42.0ft.)		(51.4ft.)								

CAPACITY CHART; F (Derated, Bigger stability)

Load radius (ft.)	14.4 ft. Boom				23.9 ft. Boom				33.3 ft. Boom				42.8 ft. Boom				52.2 ft. Boom			
	Loaded Boom Angle	Outriggers Extended		Loaded Boom Angle	Outriggers Extended		Loaded Boom Angle	Outriggers Extended		Loaded Boom Angle	Outriggers Extended Max.	Loaded Boom Angle	Outriggers Extended Max.	Loaded Boom Angle	Outriggers Extended Max.					
		Max.	Min.		Max.	Min.		Max.	Min.											
5	72°	14,000	8,800	80°	13,200	8,800	82°	6,600	6,350											
6	68°	14,000	8,800	78°	13,200	8,800	82°	6,600	6,350	82°	6,600									
8	58°	13,000	7,850	73°	13,000	7,850	79°	6,600	5,700	80°	6,600	82°	5,700	82°	5,700					
10	47°	10,550	5,700	68°	10,550	5,700	75°	6,600	4,200	77°	6,600	80°	5,700	80°	5,700					
12	33°	8,900	4,250	62°	8,900	4,200	72°	6,600	2,550	72°	5,900	76°	5,700	76°	5,700					
16				50°	6,600	2,550	64°	6,150	2,550	72°	5,900	76°	5,700	76°	5,700					
20				34°	4,750	1,700	56°	4,750	1,700	65°	4,300	71°	4,300	71°	4,300					
25							44°	3,400	1,100	57°	3,300	65°	3,250	65°	3,250					
30							27°	2,450	600	48°	2,450	58°	2,450	58°	2,450					
35										38°	2,050	51°	2,050	51°	2,050					
40										22°	1,550	43°	1,550	43°	1,550					
45												33°	1,300	33°	1,300					
	1°	7,800	3,500	1°	3,850	1,250	1°	2,200	500	1°	1,450	1°	950	1°	950					
		(13.6ft.)			(23.1ft.)			(32.5ft.)		(42.0ft.)		(51.4ft.)								

Notice: The chart is only for reference and should not be used for operation. Maintain a clearances at least 10 feet between any part of the crane, load line or load and any electrical line carrying up to 50,000 volts. One- foot additional clearance is required for every additional 30,000 volts or less.

TM-1052 (10 ton) crane capacity

WORKING RANGE

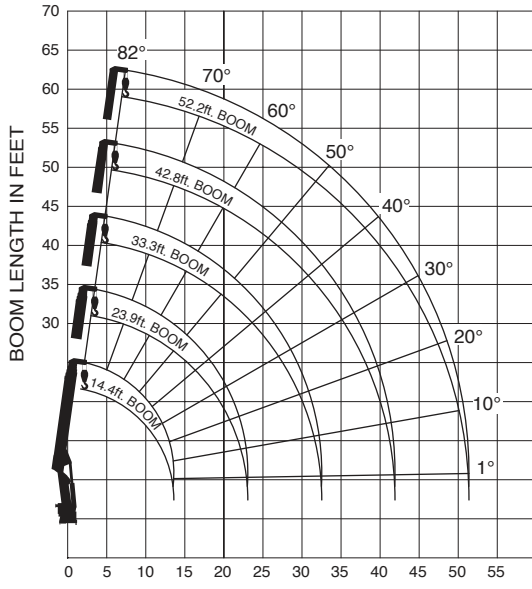

The above lifting heights and boom angles are based on a straight (unladen) boom, and allowance should be made for boom deflection obtained under laden condition.

NOTE:

- 1) Rated lifting capacities on this chart show maximum allowable loads with the outriggers properly extended on a firm surface and the crane leveled and mounted on a factory recommended truck. The rated lifting capacities in shade area are based on crane strength and others, on its stability(not to exceed 85% of tipping).
- 2) The weight of handling devices such as hook block, slings, etc., must be considered part of the load and must be deducted from the rated lifting capacities.
- 3) The operator must reduce loads to allow for such factors as wind, ground conditions, operating speed and the effects of freely suspended loads such as boom deflection.
- 4) For boom length or radius not shown, use the rated lifting capacity of next longer boom length or radius.
- 5) When outriggers are extended to mid. position, use the rated lifting capacities for outriggers extended to min. position.
- 6) For boom lengths longer than 33.3ft., extend outriggers to max. position. (in capacity chart A & C)
- 7) For boom lengths longer than 42.8ft., extend outriggers to max. position. (in capacity chart D & F)
- 8) 42.8 ft. boom means mark on 4th boom section side plate is half visible.
- 9) Maximum load for number of part lines is as shown below.

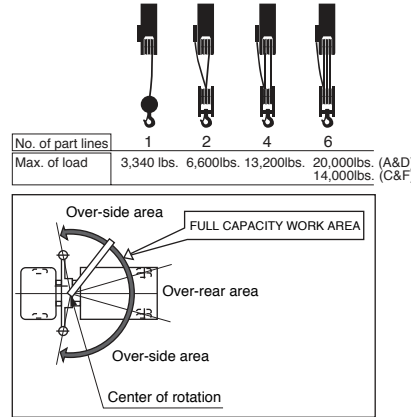

TM-1052 (10 ton) crane configurations

<CAB BACK MOUNTED>

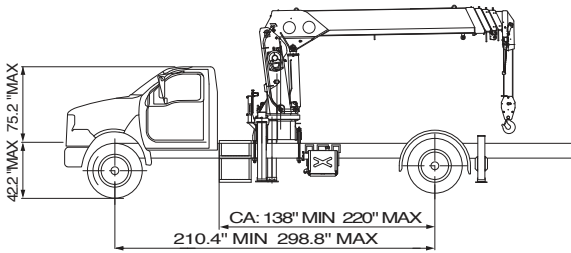

This mount requires, rear stabilizers, and additional counterweight in the underside of the truck. The complete unit must be installed in accordance with factory requirements and a test performed to determine actual stability and counterweight requirements for variety of trucks.

	CAPACITY; A,C	CAPACITY; D,F
Gross axle weight rating(GAWR),front	9,000 lbs. or more	12,000 lbs. or more
Gross axle weight rating(GAWR),rear	17,000 lbs. or more	21,000 lbs. or more
Gross vehicle weight	26,000 to 55,100 lbs.	33,000 to 55,100 lbs.
Cab to Axle(CA)	138 to 220"	
Frame Section Modulus(SM) under crane; (per rail)	15 cu. inch	110,000psi
Frame Section Modulus(SM) over rear spring hanger; (per rail)	33 cu. inch	50,000psi
over rear spring hanger; (per rail)	10 cu. inch	110,000psi
P.T.O. torque	22 cu. inch	50,000psi
P.T.O. revolution	158 ft-lbs. Min.	
Width for crane mounting	Approx. 350 to 1,750 rpm	
Frame width range (inside to outside)	Approx. 3' 7-7/8" min.	
Frame height (ground to frame top)	Approx. 2' to 3' 1-1/2"	
	Approx. 3' 6" max.	
	(Height of crane mounting base can be changed by combination of jack floats and crane bases)	

* Estimated axle scale weights prior to installation of crane and stabilizers for 85% stability. Include counterweight.

TM-1052 (10ton) crane dimensional specifications

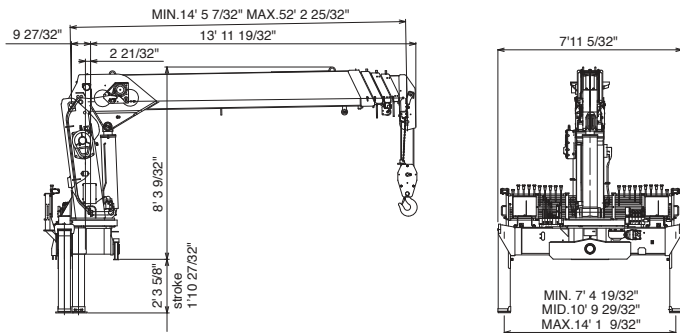

(This dimension depends on jack floats applied.)

The TADANO TM-1052 is the only true 10 ton telescopic crane offered today. With a tip height of 62 feet, this crane answers the demand for a compact, continuous rotation hydraulic crane that can be mounted in a number of configurations. With options of a work basket and radio remotes, this crane becomes an aerial work platform as well as a crane.

If you are in the market for a true 10 ton crane, the TADANO TM-1052 has the features everyone is asking for in a versatile crane package.

TADANO builds a vast range of cranes from 0.5 ton to 600 tons. No matter what your reach or lift requirements are, TADANO can provide you with a great solution. Put one to work for you now. Call today or visit our web site for more information.

Features:

Exceptional Reach without a Jib: 52.23 ft. Full powered partly synchronized Boom

Self-Aligning Pentagonal Shaped Boom: reducing maintenance cost

Light Weight: increases payload

Out & Down Mainframe Outriggers: complete level ability

Multiple Outrigger Span: easy to set up in various job sites

Faster Function Speeds: increase productivity

Superior Winch Performance: up to 147 FPM increase productivity

Shear Plate Mounting: more secure “no creep mount”

Large Hydraulic Reservoir: superior cooling capabilities

Operator Friendly: dual control stations with exceptional job site viewing

Complete Load Monitoring: TADANO’s exclusive “AMA” system



Highest Quality Boom Trucks on the Planet



TADANO AMERICA CORPORATION

333 NORTH PARK CENTRAL DRIVE, SUITE Z,
HOUSTON, TEXAS 77073 U.S.A.

PHONE: (281) 869-0030

FAX: (281) 869-0040

E-mail: sales@tadano-cranes.com

<http://www.tadanoamerica.com>