



GR-800XL-1

80 Ton Capacity (72.6 Metric Tons)

HYDRAULIC ROUGH TERRAIN CRANE

DIMENSIONS

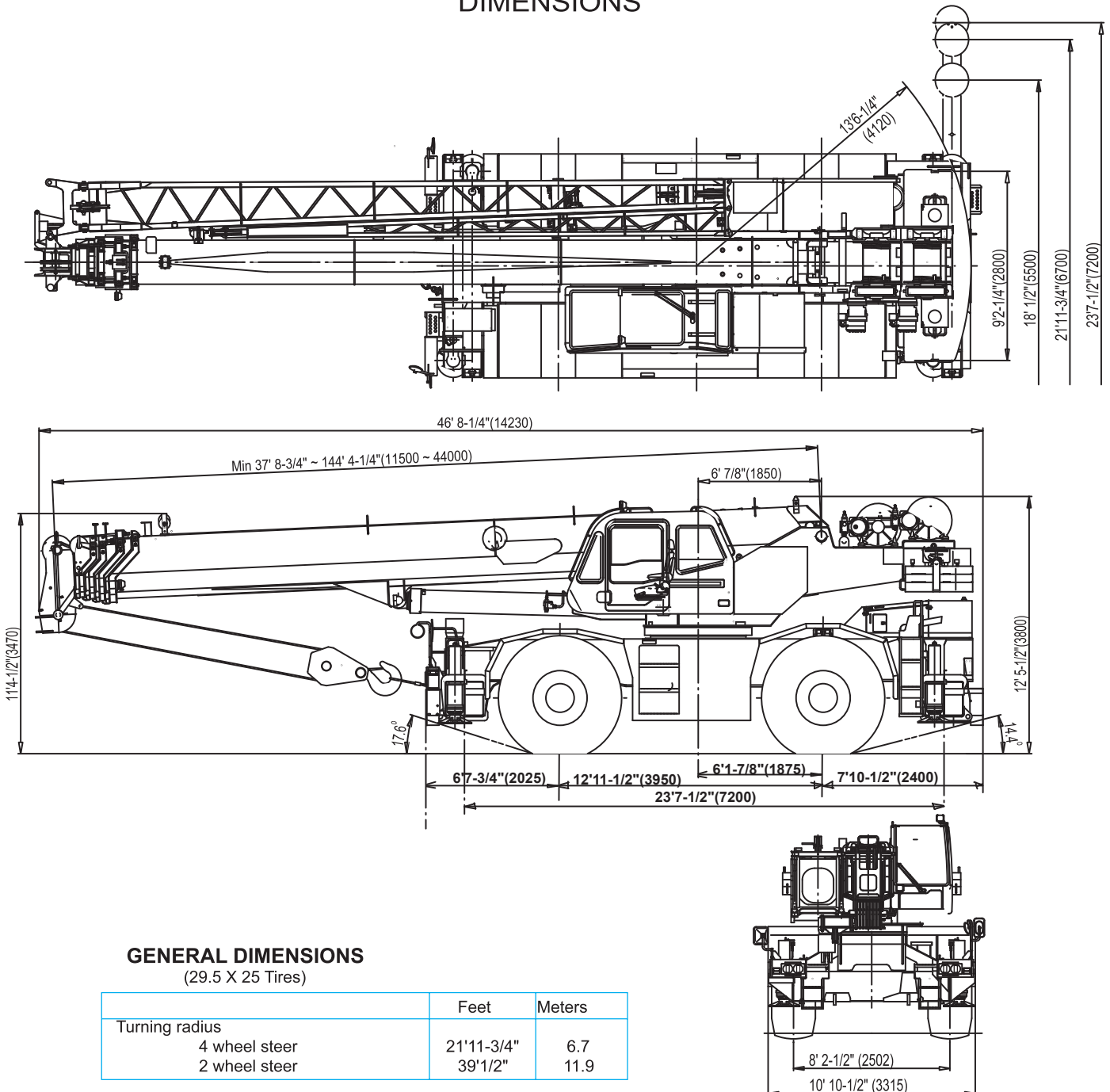

GENERAL DIMENSIONS (29.5 X 25 Tires)

	Feet	Meters
Turning radius		
4 wheel steer	21' 11-3/4"	6.7
2 wheel steer	39' 1/2"	11.9

SUPERSTRUCTURE SPECIFICATIONS

BOOM

Five section full power synchronized telescoping boom, 37.7'~144.4'(11.5m~44.0m), of round hexagonal box construction with 7 sheaves, **17 5/16"** (0.38m) root diameter, at boom head. The synchronization system consists of two telescope cylinders, an extension cable and retraction cable. Hydraulic cylinder fitted with holding valve. Two easily removable wire rope guards, rope dead end provided on both sides of boom head. Boom telescope sections are supported by wear pads both vertically and horizontally.

Extension speed 106' 7-1/2" in 145 seconds.

BOOM ELEVATION - By a double acting hydraulic cylinder with holding valve. Elevation -2.0°~80.7°, combination controls for hand or foot operation. Boom angle indicator. Automatic speed reduction and soft stop function. Elevation speed -2.0°~80.7° in 77 seconds.

JIB - Two stage bi-fold lattice type with 3.5°, 25° or 45° offset (tilt type). Single sheave, 15-5/8"(0.396m) root diameter, at the head of both jib sections. Stored alongside base boom section. Jib length is 32.5' (9.9m) or 58.1' (17.7m). Assist cylinders for mounting and stowing are controlled at right side of superstructure. Self stowing jib mounting pins.

AUXILIARY LIFTING SHEAVE (SINGLE TOP)- Single sheave, 15-5/8" (0.396m) root diameter. Mounted to main boom head for single line work (stowable).

ANTI-TWO BLOCK - Pendant type over-winding cut out device with audio-visual (FAILURE lamp/BUZZER) warning system.

SWING

Hydraulic axial piston motor driven through planetary swing speed reducer. Continuous 360° full circle swing on ball bearing turntable at 2.3rpm. Equipped with manually locked/released swing brake. A 360° positive swing lock for pick and carry and travel modes, manually engaged in cab. Twin swing System: Free swing or lock swing controlled by selector switch on front console.

HOIST

MAIN HOIST - Variable speed type with grooved drum driven by hydraulic axial piston motor through winch speed reducer. Power load lowering and raising. Equipped with automatic brake (neutral brake) and counterbalance valve. Controlled independently of main hoist. Equipped with cable follower and drum rotation indicator.

DRUM - Grooved 15-3/4"(0.40m) root diameter x 22-3/4" (0.578m) wide. Wire rope: 797' of 3/4"diameter rope (243m of 19mm). Drum capacity: 1,096' (334m) 7 layers. Maximum line pull (available): 18,200lbs. (8,260kg). Maximum line speed: 585FPM (178m/min).

AUXILIARY HOIST - Variable speed type with grooved drum driven by hydraulic axial piston motor through winch speed reducer. Power load lowering and raising. Equipped with automatic brake (neutral brake) and counterbalance valve. Controlled independently of main hoist. Equipped with cable follower and drum rotation indicator.

DRUM - Grooved 15-3/4"(0.40m) root diameter x 22-3/4" (0.578m) wide. Wire rope: 436' of 3/4"diameter rope (133m of 19mm). Drum capacity: 1,096' (334m) 7 layers. Maximum line pull (available): 18,200lbs. (8,260kg). Maximum line speed: 585FPM (178m/min).

WIRE ROPE - Warrington seal wire, extra improved plow steel, preformed, independent wire rope core, right regular lay. 3/4"(19 mm) 6X37 class

HOOK BLOCKS

- 80 ton (72.6 metric ton) - 7 Sheave with swivel hook and safety latch for 3/4" (19mm) wire rope.
- 6.2 ton (5.6 metric ton) - Weighted hook with swivel and safety latch, for 3/4"(19mm) wire rope.

HYDRAULIC SYSTEM

PUMPS - Two variable piston pumps for crane functions. Tandem gear pump for steering, swing and optional equipment. Powered by carrier engine. Pump disconnect for crane is engaged/ disengaged by rotary switch from operator's cab.

CONTROL VALVES - Multiple valves actuated by pilot pressure with integral pressure relief valves.

RESERVOIR - 195 gallon (740 lit.) capacity. External sight level gauge.

FILTRATION - 26 micron return filter, full flow with bypass protection, located inside of hydraulic reservoir. Accessible for easy replacement.

OIL COOLER - Air cooled fan type.

CAB AND CONTROLS

Both crane and drive operations can be performed from one cab mounted on rotating superstructure.

Left side, 1 man type, steel construction with sliding door access and tinted safety glass windows opening at side. Door window is powered control. Windshield glass and roof window glass are shatter-resistant. Tilt-telescoping steering wheel. Adjustable control lever stands for swing, boom hoist, boom telescoping, auxiliary hoist and main hoist. Control lever stands can change neutral positions and tilt for easy access into cab. 3 way adjustable operator's seat with high back, headrest and armrest. Engine throttle knob. Foot operated controls: boom hoist, boom telescoping, service brake and engine throttle. Hot water cab heater and air conditioning.

Dash-mounted engine start/stop, monitor lamps, cigarette lighter ashtray, drive selector switch, parking brake switch, steering mode select switch, power window switch, pump engaged/ disengaged switch, swing brake switch, telescoping/auxiliary winch select switch, outrigger controls, main winch/auxiliary winch selector switch, swing stop cancel switch, slow elevation stop cancel switch and free swing / lock swing selector switch.

Instruments - Torque converter oil temperature, engine water temperature, air pressure, fuel, speedometer, tachometer and hour meter. Hydraulic oil pressure is monitored and displayed on the AML-L display panel.

Tadano electronic LOAD MOMENT INDICATOR system (AML-L) including:

- Control lever lockout function with audible and visual pre-warning.
- Boom position indicator
- Outrigger state indicator
- Boom angle / boom length / jib offset angle / load radius / rated lifting capacities / actual loads read out
- Ratio of actual load moment to rated load moment indication
- Automatic Speed Reduction and Soft Stop function on boom elevation and swing (swing range restricted only)
- Working condition register switch
- Load radius / boom angle / tip height / swing range preset function
- External warning lamp

TADANO AML-L monitors outrigger extended length and automatically programs the corresponding "RATED LIFTING CAPACITIES" table.

Operator's right hand console includes transmission gear selector and sight level bubble. Upper console includes working light switch, roof washer and wiper switch, oil cooler switch, emergency outrigger set up key switch, drum indicator switch, jib equipped/removed select switch, boom emergency telescoping switch (2nd and 3rd-top) and air conditioning control switch. Swing lock lever.

NOTE: Each crane motion speed is based on unladen conditions.

CARRIER SPECIFICATIONS

TYPE - Rear engine, left hand steering, driving axle 2-way selected type by manual switch, 4x2 front drive, 4x4 front and rear drive.

FRAME - High tensile steel, all welded mono-box construction.

TRANSMISSION - Electronically controlled full automatic transmission. Torque converter driving full powershift with driving axle selector. 6 forward and 2 reverse speeds, constant mesh.

- 3 speeds - high range - 2 wheel drive; 4 wheel drive
- 3 speeds - low range - 4 wheel drive

TRAVEL SPEED - 25 mph (40 km/h)

AXLE - Front: Full floating type, steering and driving axle with planetary reduction. Rear: Full floating type, steering and driving axle with planetary reduction and non-spin rear differential.

STEERING- Hydraulic power steering controlled by steering wheel. Four steering modes available: 2 wheel front, 2 wheel rear, 4 wheel coordinated and 4 wheel crab .

SUSPENSION - Front: Rigid mounted to frame. Rear: Pivot mounted with hydraulic lockout device.

BRAKE SYSTEMS - Service: Air over hydraulic disc brakes on all 4 wheels. Parking/Emergency: Spring applied-air released brake acting on input shaft of front axle. Auxiliary: Electro-pneumatic operated exhaust brake.

TIRES - 29.5-25 22PR(OR) or 29.5-25 28PR(OR)

OUTRIGGERS - Four hydraulic, beam and jack outriggers. Vertical jack cylinders equipped with integral holding valve. Each outrigger beam and jack is controlled independently from cab. Beams extend to 23' 7-1/2" (7.2 m) center-line and retract to within 10' 10-1/2" (3.315 m) overall width with floats. Outrigger jack floats are attached thus eliminating the need of manually attaching and detaching them. Controls and sight bubble located in superstructure cab. Four outrigger extension lengths are provided with corresponding "RATED LIFTING CAPACITIES" for crane duty in confined areas.

- Min. Extension 9' 2-1/4" center to center
- Mid. Extension 18' 1/2" center to center
- Mid. Extension 21' 11-3/4" center to center
- Max. Extension 23' 7-1/2" center to center

Float size(Diameter) 1' 7-11/16" (0.5m)

ENGINE

Model	Mitsubishi 6M60-TLA3B
Type	Direct injection diesel
No. of cylinders	6
Combustion	4 cycle, turbo charged and after cooled
BoreXStroke, in.(mm)	4.646 X 4.528 (118X115)
Displacement, cu. in (liters)	460 (7.545)
Air inlet heater	24 volt preheat
Air cleaner	Dry type, replaceable element
Oil filter	Full flow with replaceable element
Fuel filter	Full flow with replaceable element
Fuel tank, gal.(liters)	79.2 (300), right side of carrier
Cooling	Liquid pressurized, recirculating by-pass

Radiator	Fin and tube core, thermostat controlled
Fan, in.(mm)	Suction type, 6-blade, 23.6 (600) dia.
Starting	24 volt
Charging	24 volt system, negative ground
Battery	2-120 amp. Hour
Compressor, air, CFM(l /min)	29 CFM (830) at 2,600 rpm
Horsepower (kW)	Gross 267 (200) at 2,600 rpm
Torque, Max. ft-lb (kgm)	579 (80) at 1,400 rpm
Capacity, gal.(liters)	
Cooling water	3.4 (13)
Lubrication	3.4-4.0 (13-15)
Fuel	79.2 (300)

STANDARD EQUIPMENT

- Four section full power partially synchronized boom 37.7'~144.4' (11.5 m~44.0 m)
- 32.5'~58.1' (9.9 m~17.7 m) bi-fold lattice jib (tilt type) with 3.5°, 25° or 45° pinned offsets and self storing pins.
- Auxiliary lifting sheave (single top) stowable
- Variable speed main hoist with grooved drum, cable follower and 797' of 3/4" cable.
- Variable speed auxiliary hoist with grooved drum, cable follower and 436' of 3/4" cable.
- Drum rotation indicator (thumper type) main and auxiliary hoist
- Anti-Two block device (overwind cutout)
- Boom angle indicator
- Tadano electronic load moment indicator system (AML-L)
- Outrigger extension length detector
- Electronic crane monitoring system
- Tadano twin swing system and 360° positive swing lock
- Self centering finger control levers with pilot control
- Control pedals for boom hoist and boom telescoping
- 3 way adjustable cloth seat with armrests, high back and seat belt
- Tilt-telescoping steering wheel
- Tinted safety glass and sun visor
- Front windshield wiper and washer
- Roof window wiper and washer
- Power window (cab door)
- Rear view mirrors (right and left side)
- Mirror for main and auxiliary hoists
- Cigarette lighter and ashtray
- Hot water cab heater and air conditioner
- Electric fan in cab
- Cab floor mat
- Pump disconnect in operator's cab
- Hydraulic oil cooler
- Independently controlled outriggers
- Four outrigger extension positions
- Self-storing outrigger pads
- Outrigger hose protection
- Mitsubishi 6D16-TLEE turbo charged after cooled engine (223HP) with exhaust brake
- Electronic controlled automatic transmission driven by torque converter
- 4 X 4 X 4 drive/steer
- Non-spin rear differential
- Automatic rear axle oscillation lockout system
- 29.5-25 22PR (OR) tires
- Disc brakes
- Fenders
- Air dryer
- Water separator with filter
- Engine over-run alarm
- Back-up alarm
- Low oil pressure/high water temp. warning device (visual)
- Rear steer centering light
- Air cleaner dust indicator
- Full instrumentation package
- Complete highway light package
- Flood lights and work lights
- Tool storage compartment
- Tire inflation kit
- 24 volt electric system
- 80 ton (72.6 metric ton) - 7 sheave with swivel hook and safety latch for 3/4" (19 mm) wire rope
- 6.2 ton (5.6 metric ton) hook with swivel
- Hook block tie down (front bumper)
- Weighted hook storage compartment
- Towing hooks-Front and rear
- Lifting eyes

HOISTING PERFORMANCE

LINE SPEEDS AND PULLS

Layer	Speed	Main or auxiliary hoist - 15'-3/4" (0.4m) drum					
		Line speeds ²		Line pulls			
		F.P.M	m/min	Available ¹		Permissible ⁴	
		Lbs.	kgf	Lbs.	kgf	Lbs.	kgf
1st	High	378	115	18,200	8,260	15,200	6,880
2nd	High	413	126	16,700	7,570	13,900	6,310
3rd	High	448	136	15,400	6,990	12,800	5,820
4th	High	482	147	14,300	6,490	11,900	5,410
5th	High	502	157	13,400	6,060	11,100	5,050
6th ³	High	551	168	12,500	5,680	10,400	4,730
7th ³	High	585	178	11,800	5,350	9,800	4,460

¹ Developed by machinery with each layer of wire rope, but not based on rope strength or other limitation in machinery or equipment.

² Line speeds based only on hook block, not loaded.

³ Sixth layer and seventh layer of wire rope are not recommended for hoisting operations.

⁴ Permissible line pull may be affected by wire rope strength.

DRUM WIRE ROPE CAPACITIES

Wire rope layer	Main and auxiliary drum grooved lagging			
	3/4" (19mm) wire rope			
	Rope per layer		Total wire rope	
	Feet	Meters	Feet	Meters
1	123.0	37.5	123.0	37.5
2	134.2	40.9	257.2	78.4
3	145.3	44.3	402.6	122.7
4	156.5	47.7	559.1	170.4
5	167.7	51.1	726.7	221.5
6	178.8	54.5	905.5	276.0
7	190.0	57.9	1,095.5	333.9

DRUM DIMENSIONS

	Inch	mm
Root diameter	15-3/4"	400
Length	22-3/4"	578
Flange diameter	27-3/8"	695

GR-800XL-1 WORKING RANGE CHART

Telescoping Mode I

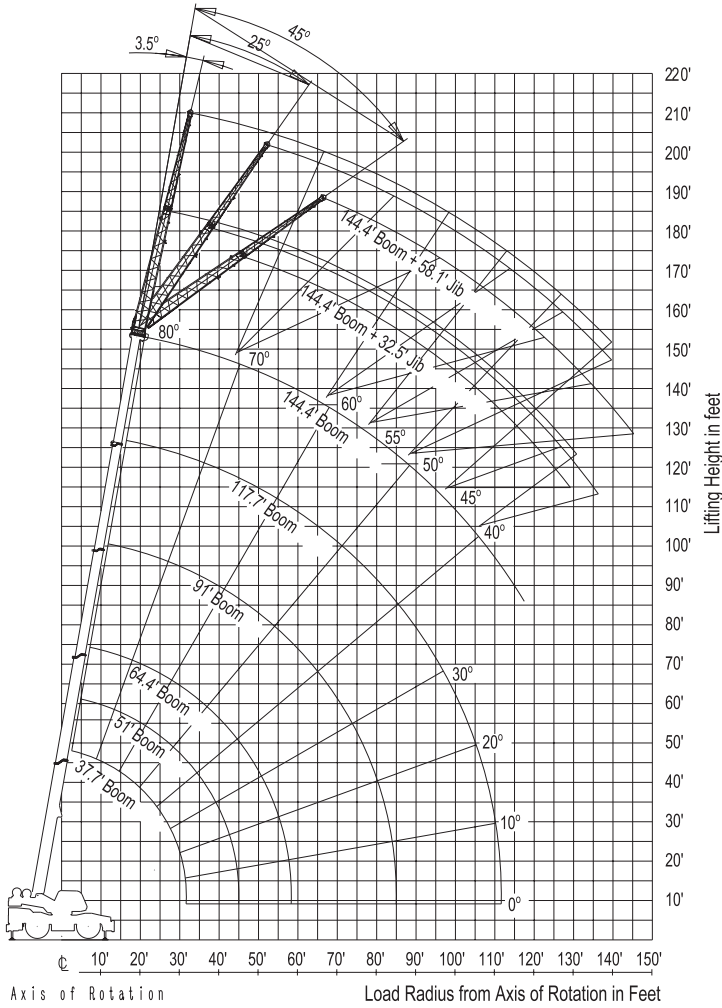

Boom Length in Feet (Telescoping Mode I)

Telescoping Mode II

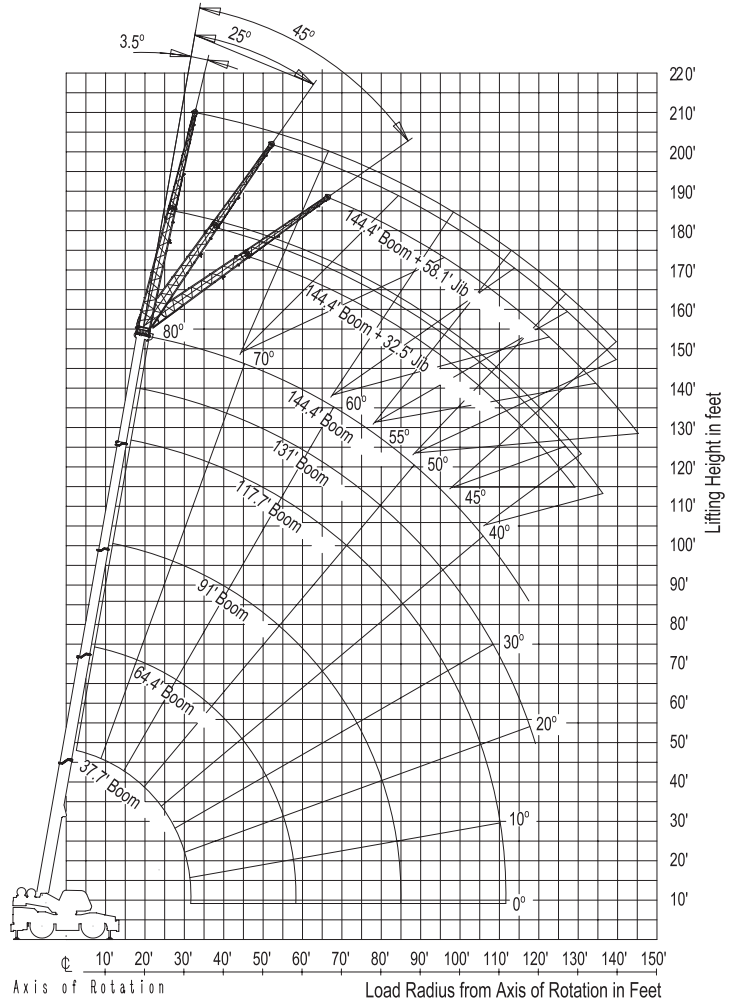

Boom Length in Feet (Telescoping Mode II)

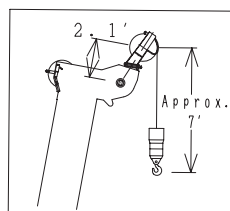
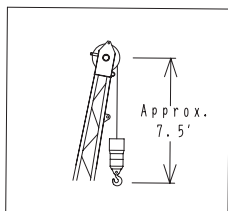
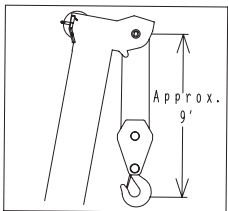
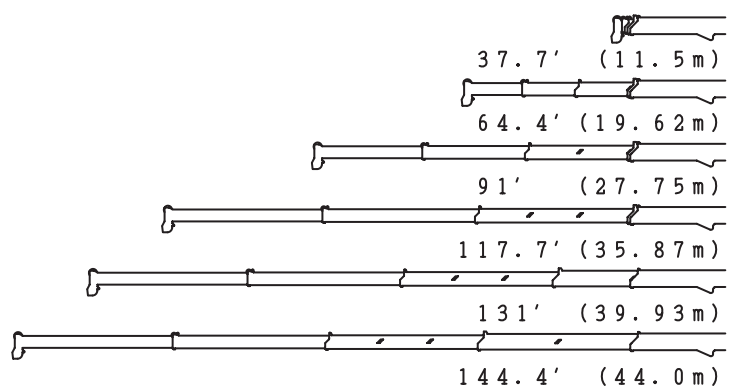
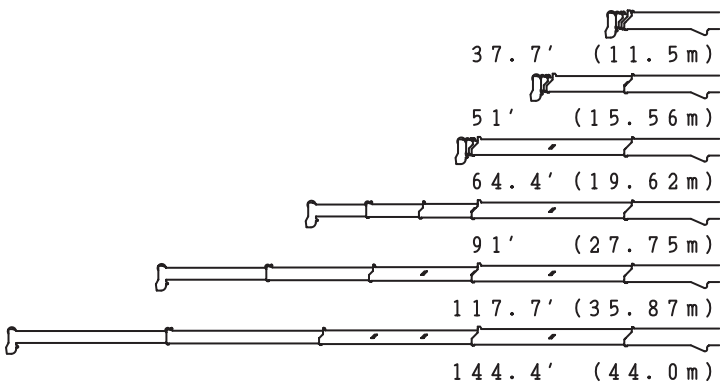

NOTE : 1. Boom and jib geometry shown are for unloaded condition and machine standing level on firm supporting surface. Boom deflection and subsequent radius and boom angle change must be accounted for when applying load to hook.

GR-800XL-1 RATED LIFTING CAPACITIES (IN POUNDS)

ON OUTRIGGERS FULLY EXTENDED 23' 7-1/2" (7.2m) SPREAD																				
360° ROTATION																				
B \ A	37.7'			51'			64.4' (19.62m)			91' (27.75m)			117.7' (35.87m)			131'		144.4'		
	C	(11.5m)	C	(15.56m)	C	(19.62m)	C	(27.75m)	C	(35.87m)	C	(44.0m)	C	(39.93m)	C	(44.0m)				
10	68	160,000	75	103,600	78	88,100	78	44,000												
12	65	125,000	72	103,600	76	88,100	76	44,000												
15	60	108,000	69	103,600	73	88,100	73	44,000	79	44,000	79	30,800								
20	50	78,400	63	77,800	69	71,900	69	44,000	76	44,000	76	30,800	79	30,800	79	17,600				
25	38	59,400	56	59,000	64	56,100	64	44,000	73	44,000	73	30,800	77	30,800	77	17,600	79	17,600	80	17,600
30	21	45,900	48	44,600	59	42,600	59	44,000	70	39,000	70	26,700	75	30,800	75	17,600	77	17,600	78	17,600
35			39	33,800	53	33,000	53	39,900	66	34,000	66	23,200	72	28,200	72	17,600	75	17,600	76	17,600
40			28	26,300	47	25,500	47	32,300	63	28,700	63	20,400	70	24,700	70	17,600	73	17,600	74	17,600
45			5	20,900	40	20,000	40	26,400	59	23,600	59	18,200	67	21,800	67	16,400	71	17,600	73	17,600
50					32	15,900	32	21,900	55	19,300	56	16,400	65	19,500	64	14,700	68	16,200	71	17,100
60									46	13,200	47	14,500	59	14,800	59	11,900	63	13,300	66	13,900
70									36	9,000	37	11,400	53	10,700	53	9,900	58	11,100	62	10,900
80									22	6,100	24	9,500	46	7,600	46	8,400	53	9,000	57	8,200
90													38	5,300	38	7,200	46	6,900	51	6,100
100													27	3,500	28	5,900	39	5,100	45	4,300
110													13	2,100	12	4,600	31	3,600	39	2,900
120																	19	2,600	32	1,800
D	0°											18°		32°						
Telescoping conditions (%)																				
Telescoping mode	I, II		I		I		II		I		II		I		II		II		I, II	
2nd boom	0		50		100		0		100		0		100		0		50		100	
3rd boom	0		0		0		33		33		66		66		100		100		100	
4th boom	0		0		0		33		33		66		66		100		100		100	
Top boom	0		0		0		33		33		66		66		100		100		100	

LIFTING CAPACITIES AT ZERO DEGREE BOOM ANGLE ON OUTRIGGERS FULLY EXTENDED																
23' 7-1/2" (7.2m) SPREAD 360° ROTATION																
C \ A	37.7'			51'			64.4' (19.62m)			91' (27.75m)			117.7' (35.87m)			
	B	(11.5m)	B	(15.56m)	B	(19.62m)	B	(19.62m)	B	(27.75m)	B	(27.75m)	B	(35.87m)	B	(35.87m)
0°	31.7	41,600	45.0	20,900	58.3	11,500	58.3	14,900	85.0	5,200	85.0	7,900	111.6	2,000	111.6	4,300
Telescoping mode	I, II		I		I		II		I		II		I		II	

- A** : Boom length in feet
- B** : Load radius in feet
- C** : Loaded boom angle (deg.)
- D** : Minimum boom angle (deg.) for indicated length (no load)

NOTE: -The lifting capacity data stored in the LOAD MOMENT INDICATOR (AML-L) is based on the standard number of parts of line listed in the chart.

-Standard number of parts of line for outrigger operation should be according to the following table.

Boom Length in Feet (meters)	37.7' (11.5m)	37.7' to 51' (11.5m to 15.56m)	51' to 64.4' (15.56m to 19.62m)	64.4' to 91' (19.62m to 27.75m)	91' to 144.4' (27.75m to 44.0m)	Single top Jib
Number of parts of line	15	10	8	4	4	1

GR-800XL-1 RATED LIFTING CAPACITIES (IN POUNDS)

ON OUTRIGGERS FULLY EXTENDED 23' 7-1/2" (7.2m) SPREAD 360° ROTATION													
C	144.4' (44.0m) Boom + 32.5' (9.9m) Jib						C	144.4' (44.0m) Boom + 58.1' (17.7m) Jib					
	3.5° Tilt		25° Tilt		45° Tilt			3.5° Tilt		25° Tilt		45° Tilt	
	R	W	R	W	R	W		R	W	R	W		
80°	32.7	9,900	44.5	8,800	52.7	8,100	80°	40.6	5,900	64.3	5,400	73.5	3,400
75°	50.3	9,900	61.2	8,700	67.6	7,300	75°	60.6	5,900	82.5	4,800	89.9	3,400
70°	66.4	9,700	75.9	7,600	81.2	6,600	70°	79.3	5,900	98.7	4,200	105.0	3,400
65°	80.5	7,900	89.3	6,600	93.9	6,000	65°	95.6	4,900	114.0	3,700	118.0	3,100
60°	93.7	6,300	102.0	5,700	106.0	5,400	60°	111.0	4,100	126.0	3,300	131.0	2,900
55°	106.0	5,100	113.0	4,500	116.0	4,300	55°	124.0	3,100	141.0	2,900	142.0	2,700
50°	117.0	3,500	124.0	3,100	125.0	3,000	50°	137.0	2,100	151.0	1,800	152.0	1,700
45°	127.0	2,200	133.0	2,000	134.0	2,000	45°	149.0	1,200				
40°	137.0	1,300	142.0	1,200									

ON OUTRIGGERS FULLY EXTENDED 23' 7-1/2" (7.2m) SPREAD 360° ROTATION													
C	117.7' (35.87m) Boom (telescoping mode I) + 32.5' (9.9m) Jib						C	117.7' (35.87m) Boom (telescoping mode I) + 58.1' (17.7m) Jib					
	3.5° Tilt		25° Tilt		45° Tilt			3.5° Tilt		25° Tilt		45° Tilt	
	R	W	R	W	R	W		R	W	R	W		
80°	26.1	12,300	37.7	11,000	44.8	8,400	80°	33.6	7,900	55.1	5,700	67.0	3,700
75°	40.1	12,300	50.7	10,000	57.0	8,000	75°	50.4	7,900	70.3	5,200	80.7	3,700
70°	53.6	12,100	62.9	8,800	68.5	7,400	70°	65.9	7,100	84.4	4,700	93.1	3,600
65°	65.7	9,900	74.6	7,700	79.0	6,700	65°	80.2	6,000	97.2	4,200	104.0	3,500
60°	76.9	8,400	85.2	6,800	88.9	6,200	60°	93.5	5,100	109.0	3,800	114.0	3,300
55°	87.6	7,000	95.4	6,000	98.2	6,000	55°	106.0	4,500	120.0	3,500	124.0	3,100
50°	97.5	5,800	104.0	5,200	106.0	5,400	50°	117.0	3,900	130.0	3,200	132.0	3,000
45°	106.0	4,300	113.0	4,000	114.0	4,200	45°	127.0	2,900	138.0	2,600	140.0	2,600
40°	115.0	3,200	120.0	3,000			40°	136.0	2,000	146.0	1,800		
35°	122.0	2,400	126.0	2,300			35°	145.0	1,300	153.0	1,200		
30°	128.0	1,700	132.0	1,700									
25°	134.0	1,200	137.0	1,200									

ON OUTRIGGERS FULLY EXTENDED 23' 7-1/2" (7.2m) SPREAD 360° ROTATION													
C	117.7' (35.87m) Boom (telescoping mode II) + 32.5' (9.9m) Jib						C	117.7' (35.87m) Boom (telescoping mode II) + 58.1' (17.7m) Jib					
	3.5° Tilt		25° Tilt		45° Tilt			3.5° Tilt		25° Tilt		45° Tilt	
	R	W	R	W	R	W		R	W	R	W		
80°	26.8	11,000	39.1	10,300	46.6	8,300	80°	34.2	6,300	56.8	5,700	67.7	3,700
75°	41.0	11,000	52.3	9,300	58.8	7,700	75°	51.0	6,300	71.7	5,100	81.4	3,700
70°	54.5	10,600	64.5	8,000	70.1	6,900	70°	67.0	6,300	85.4	4,400	93.8	3,600
65°	66.3	8,600	75.9	7,000	80.4	6,200	65°	80.9	5,300	98.4	3,900	105.0	3,300
60°	77.6	7,100	86.6	6,200	90.2	5,700	60°	94.2	4,500	110.0	3,500	115.0	3,000
55°	88.4	5,900	96.5	5,300	98.9	5,200	55°	106.0	3,900	121.0	3,100	124.0	2,800
50°	98.2	5,000	105.0	4,600	107.0	4,500	50°	118.0	3,300	131.0	2,800	132.0	2,700
45°	107.0	4,300	113.0	4,100	114.0	4,000	45°	128.0	2,800	139.0	2,600	140.0	2,500
40°	115.0	3,800	120.0	3,600			40°	137.0	2,400	147.0	2,300		
35°	122.0	3,400	127.0	3,300			35°	145.0	2,100	153.0	2,000		
30°	129.0	3,100	132.0	3,000			30°	153.0	1,900	159.0	1,800		
25°	134.0	2,800	137.0	2,800			25°	159.0	1,700	163.0	1,700		
20°	139.0	2,650					20°	164.0	1,550				
15°	142.0	2,500					15°	168.0	1,450				

C : Loaded boom angle (deg.)
R : Load radius in feet
W : Rated lifting capacity in pounds

GR-800XL-1 RATED LIFTING CAPACITIES (IN POUNDS)

ON OUTRIGGERS MID EXTENDED 21' 11-3/4" (6.7m) SPREAD																					
360° ROTATION																					
A	37.7'		51'		64.4' (19.62m)				91' (27.75m)				117.7' (35.87m)				131'		144.4'		
	B	C	C	C	C	C	C	C	C	C	C	C	C	C	C	C	C	C			
	10	68	160,000	75	103,600	78	88,100	78	44,000												
	12	65	125,000	72	103,600	76	88,100	76	44,000												
	15	60	108,000	69	103,600	73	88,100	73	44,000	79	44,000	79	30,800								
	20	50	78,400	63	77,800	69	71,900	69	44,000	76	44,000	76	30,800	79	30,800	79	17,600				
	25	38	59,400	56	56,100	64	55,200	64	44,000	73	44,000	73	30,800	77	30,800	77	17,600	79	17,600	80	17,600
	30	21	40,300	48	39,200	59	38,400	59	44,000	70	39,000	70	26,700	75	30,800	75	17,600	77	17,600	78	17,600
	35			39	29,000	53	28,200	53	35,200	66	32,000	66	23,200	72	28,200	72	17,600	75	17,600	76	17,600
	40			28	22,200	47	21,400	47	27,600	63	24,900	63	20,400	70	24,700	70	17,600	73	17,600	74	17,600
	45			5	17,000	40	16,500	40	22,200	59	19,800	59	18,200	67	21,800	67	16,400	71	17,600	73	17,600
	50					32	12,800	32	18,000	55	15,900	56	16,400	64	17,800	64	14,700	68	16,200	71	17,100
	60									46	10,500	47	14,500	59	11,900	59	11,900	63	13,300	66	12,800
	70									36	6,800	37	9,900	52	8,000	53	9,900	58	9,600	61	8,900
	80									22	4,200	24	7,100	45	5,200	46	7,800	52	6,800	56	6,100
	90													37	3,200	38	5,700	46	4,700	51	4,000
	100													27	1,600	28	4,100	39	3,100	45	2,400
	110															13	2,800	30	1,900	39	1,200
D	0°										27°		0°		30°		39°				
Telescoping conditions (%)																					
Telescoping mode	I, II		I		I		II		I		II		I		II		II		I, II		
2nd boom	0		50		100		0		100		0		100		0		50		100		
3rd boom	0		0		0		33		33		66		66		100		100		100		
4th boom	0		0		0		33		33		66		66		100		100		100		
Top boom	0		0		0		33		33		66		66		100		100		100		

LIFTING CAPACITIES AT ZERO DEGREE BOOM ANGLE ON OUTRIGGERS MID EXTENDED														
21' 11-3/4" (6.7m) SPREAD 360° ROTATION														
A	37.7'		51'		64.4'		64.4'		91'		91'		117.7'	
	B	C	B	C	B	C	B	C	B	C	B	C	B	C
0°	31.7	36,400	45.0	17,000	58.3	9,000	58.3	14,300	85.0	3,200	85.0	6,000		
Telescoping mode	I, II		I		I		II		I		II		II	

- A** : Boom length in feet
- B** : Load radius in feet
- C** : Loaded boom angle (deg.)
- D** : Minimum boom angle (deg.) for indicated length (no load)

NOTE: -The lifting capacity data stored in the LOAD MOMENT INDICATOR (AML-L) is based on the standard number of parts of line listed in the chart.

-Standard number of parts of line for outrigger operation should be according to the following table.

Boom Length in Feet (meters)	37.7' (11.5m)	37.7' to 51' (11.5m to 15.56m)	51' to 64.4' (15.56m to 19.62m)	64.4' to 91' (19.62m to 27.75m)	91' to 144.4' (27.75m to 44.0m)	Single top Jib
Number of parts of line	15	10	8	4	4	1

GR-800XL-1 RATED LIFTING CAPACITIES (IN POUNDS)

ON OUTRIGGERS MID EXTENDED 21' 11-3/4" (6.7m) SPREAD 360° ROTATION							ON OUTRIGGERS MID EXTENDED 21' 11-3/4" (6.7m) SPREAD 360° ROTATION						
C	144.4' (44.0m) Boom + 32.5' (9.9m) Jib						C	144.4' (44.0m) Boom + 58.1' (17.7m) Jib					
	3.5° Tilt		25° Tilt		45° Tilt			3.5° Tilt		25° Tilt		45° Tilt	
	R	W	R	W	R	W		R	W	R	W	R	W
80°	32.7	9,900	44.5	8,800	52.7	8,100	80°	40.6	5,900	64.3	5,400	73.5	3,400
75°	50.3	9,900	61.2	8,700	67.6	7,300	75°	60.6	5,900	82.5	4,800	89.9	3,400
70°	66.4	9,700	75.9	7,600	81.2	6,600	70°	79.3	5,900	98.7	4,200	105.0	3,400
65°	80.0	7,200	89.3	6,600	93.9	6,000	65°	95.6	4,900	114.0	3,700	118.0	3,100
60°	92.4	4,700	101.0	4,400	105.0	4,100	60°	110.0	3,400	127.0	2,800	130.0	2,500
55°	104.0	2,900	112.0	2,700	115.0	2,600	55°	123.0	1,800	138.0	1,500	141.0	1,400
50°	115.0	1,600	122.0	1,500	124.0	1,500							

ON OUTRIGGERS MID EXTENDED 21' 11-3/4" (6.7m) SPREAD 360° ROTATION							ON OUTRIGGERS MID EXTENDED 21' 11-3/4" (6.7m) SPREAD 360° ROTATION						
C	117.7' (35.87m) Boom (telescoping mode I) + 32.5' (9.9m) Jib						C	117.7' (35.87m) Boom (telescoping mode I) + 58.1' (17.7m) Jib					
	3.5° Tilt		25° Tilt		45° Tilt			3.5° Tilt		25° Tilt		45° Tilt	
	R	W	R	W	R	W		R	W	R	W	R	W
80°	26.1	12,300	37.7	11,000	44.8	8,400	80°	33.6	7,900	55.1	5,700	67.0	3,700
75°	40.1	12,300	50.7	10,000	57.0	8,000	75°	50.4	7,900	70.3	5,200	80.7	3,700
70°	53.6	12,100	62.9	8,800	68.5	7,400	70°	65.9	7,100	84.4	4,700	93.1	3,600
65°	65.7	9,900	74.6	7,700	79.0	6,700	65°	80.2	6,000	97.2	4,200	104.0	3,500
60°	76.9	8,100	85.2	6,800	88.9	6,200	60°	93.5	5,100	109.0	3,800	114.0	3,300
55°	87.2	5,700	94.8	5,100	97.7	4,700	55°	105.0	3,800	120.0	3,300	124.0	3,000
50°	96.8	3,900	104.0	3,500	106.0	3,400	50°	116.0	2,500	129.0	2,100	132.0	2,000
45°	106.0	2,600	112.0	2,300	113.0	2,300	45°	126.0	1,400	138.0	1,300	139.0	1,200
40°	114.0	1,600	119.0	1,400									

ON OUTRIGGERS MID EXTENDED 21' 11-3/4" (6.7m) SPREAD 360° ROTATION							ON OUTRIGGERS MID EXTENDED 21' 11-3/4" (6.7m) SPREAD 360° ROTATION						
C	117.7' (35.87m) Boom (telescoping mode II) + 32.5' (9.9m) Jib						C	117.7' (35.87m) Boom (telescoping mode II) + 58.1' (17.7m) Jib					
	3.5° Tilt		25° Tilt		45° Tilt			3.5° Tilt		25° Tilt		45° Tilt	
	R	W	R	W	R	W		R	W	R	W	R	W
80°	26.8	11,000	39.1	10,300	46.6	8,300	80°	34.2	6,300	56.8	5,700	67.7	3,700
75°	41.0	11,000	52.3	9,300	58.8	7,700	75°	51.0	6,300	71.7	5,100	81.4	3,700
70°	54.5	10,600	64.5	8,000	70.1	6,900	70°	67.0	6,300	85.4	4,400	93.8	3,600
65°	66.3	8,600	75.9	7,000	80.4	6,200	65°	80.9	5,300	98.4	3,900	105.0	3,300
60°	77.6	7,100	86.6	6,200	90.2	5,700	60°	94.2	4,500	110.0	3,500	115.0	3,000
55°	88.4	5,900	96.5	5,300	98.9	5,200	55°	106.0	3,900	121.0	3,100	124.0	2,800
50°	98.2	5,000	105.0	4,600	107.0	4,500	50°	118.0	3,300	131.0	2,800	132.0	2,700
45°	107.0	4,300	113.0	4,100	114.0	4,000	45°	128.0	2,800	139.0	2,600	140.0	2,500
40°	115.0	3,400	120.0	3,300			40°	137.0	2,100	146.0	2,000		
35°	122.0	2,700	126.0	2,600			35°	145.0	1,500	153.0	1,400		
30°	128.0	2,100	132.0	2,100			30°	152.0	1,100				
25°	134.0	1,700	137.0	1,700									
20°	138.0	1,400											
15°	142.0	1,200											

C :Loaded boom angle (deg.)
R :Load radius in feet
W :Rated lifting capacity in pounds

GR-800XL-1 RATED LIFTING CAPACITIES (IN POUNDS)

ON OUTRIGGERS MID EXTENDED 18' 1/2" (5.5m) SPREAD																					
360° ROTATION																					
B	A	37.7'		51'		64.4' (19.62m)				91' (27.75m)				117.7' (35.87m)				131'		144.4'	
	C	(11.5m)	C	(15.56m)	C	C	C	C	C	C	C	C	C	C	C	C	(39.93m)	C	(44.0m)		
10	68	160,000	75	103,600	78	88,100	78	44,000													
12	65	125,000	72	103,600	76	88,100	76	44,000													
15	60	108,000	69	103,600	73	88,100	73	44,000	79	44,000	79	30,800									
20	50	64,600	62	62,400	69	61,500	69	44,000	76	44,000	76	30,800	79	30,800	79	17,600					
25	38	42,600	56	41,400	64	40,600	64	44,000	73	43,500	73	30,800	77	30,800	77	17,600	79	17,600	80	17,600	
30	21	29,100	48	30,300	59	28,200	59	34,200	70	31,600	70	26,700	75	30,800	75	17,600	77	17,600	78	17,600	
35			39	21,100	53	20,300	53	26,100	66	23,700	66	23,200	72	26,100	72	17,600	75	17,600	76	17,600	
40			28	15,700	47	15,000	47	20,500	62	18,200	63	20,400	70	20,300	70	17,600	73	17,600	74	17,600	
45			5	11,600	40	11,000	40	16,300	59	14,200	59	18,000	67	16,100	67	16,400	71	17,600	73	16,900	
50					32	8,000	32	13,100	55	11,100	55	14,700	64	12,800	64	14,700	68	14,700	70	13,600	
60									46	6,600	46	10,000	58	8,100	59	10,900	63	9,900	66	8,900	
70									36	3,500	36	6,800	52	4,900	52	7,600	57	6,700	61	5,700	
80									21	1,400	23	4,600	45	2,700	45	5,300	52	4,300	56	3,500	
90															37	3,500	45	2,600	50	1,800	
100															27	2,200	38	1,200			
110															12	1,100					
D	0°										41°		12°		38°		50°				
Telescoping conditions (%)																					
Telescoping mode	I, II	I	I	II	I	II	I	II	I	II	I	II	II	II	I, II						
2nd boom	0	50	100	0	100	0	100	0	100	0	100	0	50	100							
3rd boom	0	0	0	33	33	66	66	100	100	100											
4th boom	0	0	0	33	33	66	66	100	100	100											
Top boom	0	0	0	33	33	66	66	100	100	100											

LIFTING CAPACITIES AT ZERO DEGREE BOOM ANGLE ON OUTRIGGERS MID EXTENDED													
18' 1/2" (5.5m) SPREAD 360° ROTATION													
C	A	37.7'		51'		64.4'		64.4'		91'		91'	
	B	(11.5m)	B	(15.56m)	B	(19.62m)	B	(19.62m)	B	(27.75m)	B	(27.75m)	
0°	31.7	26,400	45.0	11,600	58.3	5,000	58.3	9,700	85.0	1,100	85.0	3,700	
Telescoping mode	I, II	I	I	II	I	II							

- A :Boom length in feet
- B :Load radius in feet
- C :Loaded boom angle (deg.)
- D :Minimum boom angle (deg.) for indicated length (no load)

NOTE: -The lifting capacity data stored in the LOAD MOMENT INDICATOR (AML-L) is based on the standard number of parts of line listed in the chart.

-Standard number of parts of line for outrigger operation should be according to the following table.

Boom Length in Feet (meters)	37.7' (11.5m)	37.7' to 51' (11.5m to 15.56m)	51' to 64.4' (15.56m to 19.62m)	64.4' to 91' (19.62m to 27.75m)	91' to 144.4' (27.75m to 44.0m)	Single top Jib
Number of parts of line	15	10	8	4	4	1

GR-800XL-1 RATED LIFTING CAPACITIES (IN POUNDS)

ON OUTRIGGERS MID EXTENDED 18' 1/2" (5.5m) SPREAD 360° ROTATION													
C	144.4' (44.0m) Boom + 32.5' (9.9m) Jib						144.4' (44.0m) Boom + 58.1' (17.7m) Jib						
	3.5° Tilt		25° Tilt		45° Tilt		3.5° Tilt		25° Tilt		45° Tilt		
	R	W	R	W	R	W	R	W	R	W	R	W	
80°	32.7	9,900	44.5	8,800	52.7	8,100	40.6	5,900	64.3	5,400	73.5	3,400	
75°	50.3	9,900	61.2	8,700	67.6	7,300	60.6	5,900	82.5	4,800	89.9	3,400	
70°	65.3	8,000	75.0	6,700	80.9	6,300	78.6	5,400	98.7	4,200	105.0	3,400	
65°	78.3	5,000	87.5	4,100	92.5	4,000	65°	93.2	3,100	112.0	2,000	117.0	2,400
60°	90.9	2,800	99.2	2,300	103.0	2,300	60°	107.0	1,500	125.0	1,300	129.0	1,100
55°	102.0	1,300	111.0	1,100	114.0	1,100							

ON OUTRIGGERS MID EXTENDED 18' 1/2" (5.5m) SPREAD 360° ROTATION													
C	117.7' (35.87m) Boom (telescoping mode I) + 32.5' (9.9m) Jib						117.7' (35.87m) Boom (telescoping mode I) + 58.1' (17.7m) Jib						
	3.5° Tilt		25° Tilt		45° Tilt		3.5° Tilt		25° Tilt		45° Tilt		
	R	W	R	W	R	W	R	W	R	W	R	W	
80°	26.1	12,300	37.7	11,000	44.8	8,400	33.6	7,900	55.1	5,700	67.0	3,700	
75°	40.1	12,300	50.7	10,000	57.0	8,000	50.4	7,900	70.3	5,200	80.7	3,700	
70°	53.1	11,000	62.9	8,800	68.5	7,400	65.9	7,100	84.4	4,700	93.1	3,600	
65°	65.0	8,100	74.4	7,300	78.9	6,200	65°	79.9	5,700	97.2	4,200	104.0	3,500
60°	75.6	5,300	84.4	4,800	88.4	4,200	60°	92.0	3,500	108.0	3,000	114.0	2,600
55°	86.2	3,300	94.0	3,000	97.2	2,700	55°	104.0	1,900	119.0	1,700	123.0	1,500
50°	95.8	1,800	103.0	1,700	105.0	1,600							

ON OUTRIGGERS MID EXTENDED 18' 1/2" (5.5m) SPREAD 360° ROTATION													
C	117.7' (35.87m) Boom (telescoping mode II) + 32.5' (9.9m) Jib						117.7' (35.87m) Boom (telescoping mode II) + 58.1' (17.7m) Jib						
	3.5° Tilt		25° Tilt		45° Tilt		3.5° Tilt		25° Tilt		45° Tilt		
	R	W	R	W	R	W	R	W	R	W	R	W	
80°	26.8	11,000	39.1	10,300	46.6	8,300	34.2	6,300	56.8	5,700	67.7	3,700	
75°	41.0	11,000	52.3	9,300	58.8	7,700	51.0	6,300	71.7	5,100	81.4	3,700	
70°	54.5	10,600	64.5	8,000	70.1	6,900	67.0	6,300	85.4	4,400	93.8	3,600	
65°	66.3	8,600	75.9	7,000	80.4	6,200	65°	80.9	5,300	98.4	3,900	105.0	3,300
60°	77.5	7,000	86.6	6,200	90.2	5,700	60°	94.2	4,500	110.0	3,500	115.0	3,000
55°	87.8	5,000	96.0	4,700	98.5	4,300	55°	106.0	3,500	121.0	3,000	124.0	2,700
50°	97.4	3,600	104.0	3,400	106.0	3,200	50°	117.0	2,300	130.0	2,000	132.0	1,800
45°	106.0	2,500	112.0	2,500	114.0	2,300	45°	127.0	1,500	138.0	1,300	139.0	1,200
40°	114.0	1,700	119.0	1,700									
35°	121.0	1,200	126.0	1,100									

C :Loaded boom angle (deg.)
R :Load radius in feet
W :Rated lifting capacity in pounds

GR-800XL-1 RATED LIFTING CAPACITIES (IN POUNDS)

ON OUTRIGGERS MIN EXTENDED 9' 2-1/2" (2.8m) SPREAD																			
360° ROTATION																			
B	A	37.7'		51'		64.4' (19.62m)		91' (27.75m)		117.7' (35.87m)		131'		144.4'					
	C	(11.5m)	C	(15.56m)	C	C	C	C	C	C	C	C	(39.93m)	C	(44.0m)				
10	68	84,100	75	77,900	78	76,000	78	44,000											
12	65	62,000	72	58,200	76	56,800	76	44,000											
15	60	42,400	68	40,000	73	39,000	73	43,800	79	41,700	79	30,800							
20	50	25,700	62	23,900	69	23,200	69	28,700	76	26,600	76	30,500	79	28,400	79	17,600			
25	38	16,800	55	15,300	64	14,600	64	19,900	72	17,800	72	21,600	77	19,500	77	17,600			
30	21	11,000	48	9,900	59	9,200	58	14,300	69	12,400	69	15,900	74	13,900	75	16,600			
35			39	6,200	53	5,500	53	10,400	65	8,600	66	11,900	72	9,900	72	12,700			
40			28	3,400	47	2,800	47	7,400	62	5,600	62	8,900	69	6,900	69	9,600			
45			5	1,300			40	5,200	58	3,400	58	6,700	66	4,700	66	7,300			
50							32	3,400	54	1,700	54	4,900	63	2,900	64	5,600			
60											45	2,300			58	3,000			
70														51	1,200				
D		0°		44°		0°		54°		43°		61°		51°		61°		65°	
Telescoping conditions (%)																			
Telescoping mode		I, II	I	I	I	II	I	II	I	II	I	II	II	II	I, II				
2nd boom		0	50	100	0	0	100	0	100	0	100	0	50	100					
3rd boom		0	0	0	33	33	66	66	100	100	100	100	100	100					
4th boom		0	0	0	33	33	66	66	100	100	100	100	100	100					
Top boom		0	0	0	33	33	66	66	100	100	100	100	100	100					

LIFTING CAPACITIES AT ZERO DEGREE BOOM ANGLE ON OUTRIGGERS MID EXTENDED											
9' 2-1/2" (2.8m) SPREAD 360° ROTATION											
C	A	37.7'		51'		64.4'					
	B	(11.5m)	B	(15.56m)	B	(19.62m)					
0°	31.7	9,400	45.0	1,300		58.3	1,700				
Telescoping mode		I, II	I			II					

- A :Boom length in feet
- B :Load radius in feet
- C :Loaded boom angle (deg.)
- D :Minimum boom angle (deg.) for indicated length (no load)

NOTE: -The lifting capacity data stored in the LOAD MOMENT INDICATOR (AML-L) is based on the standard number of parts of line listed in the chart.

-Standard number of parts of line for outrigger operation should be according to the following table.

Boom Length in Feet (meters)	37.7' (11.5m)	37.7' to 51' (11.5m to 15.56m)	51' to 64.4' (15.56m to 19.62m)	64.4' to 91' (19.62m to 27.75m)	91' to 144.4' (27.75m to 44.0m)	Single top Jib
Number of parts of line	8	7	7	4	4	1

WARNING AND OPERATING INSTRUCTIONS FOR LIFTING CAPACITIES

GENERAL

1. RATED LIFTING CAPACITIES apply only to the machine as originally manufactured and normally equipped by TADANO LTD. Modifications to the machine or use of optional equipment other than that specified can result in a reduction of capacity.
2. Construction equipment can be hazardous if improperly operated or maintained. Operation and maintenance of this machine must be in compliance with information in the operation, safety and maintenance manual supplied with machine. If these manuals are missing, order replacements through the distributor.
3. The operator and other personnel associated with this machine shall fully acquaint themselves with the latest American National Standards Institute (ANSI) safety standards for cranes.

SET UP

1. Rated lifting capacities on the chart are the maximum allowable crane capacities and are based on the machine standing level on firm supporting surface under ideal job conditions. Depending on the nature of the supporting surface, it may be necessary to have structural supports under the outrigger floats or tires to spread the loads to a larger bearing surface.
2. For outrigger operation, outriggers shall be properly extended with tires free of supporting surface before operating crane.

OPERATION

1. Rated lifting capacities have been tested to and meet minimum requirements of SAE J1063-Cantilevered Boom Crane Structures Method of Test.
2. Rated lifting capacities do not exceed 85 % of the tipping load on outriggers fully extended as determined by SAE J765-Crane Stability Test Code.
Rated lifting capacities for partially extended outriggers are determined from the formula, Rated Lifting Capacities = (Tipping Load - 0.1 x Tip Reaction) / 1.25.
3. Rated lifting capacities above bold lines in the chart are based on crane strength and those below, on its stability. They are based on actual load radius increased by boom deflection.
4. The weight of handling device such as hook blocks, slings, etc., must be considered as part of the load and must be deducted from the lifting capacities.
5. Rated lifting capacities are based on freely suspended loads and make no allowance for such factors as the effect of wind, sudden stopping of loads, supporting surface conditions, inflation of tires, operating speeds, side loads, etc. Side pull on boom or jib is extremely dangerous.
6. Rated lifting capacities do not account for wind on lifted load or boom. Rated lifting capacities and boom length shall be appropriately reduced, when wind velocity is above 20 mph (9 m/sec.).
7. Rated lifting capacities at load radius shall not be exceeded. Do not tip the crane to determine allowable loads.
8. Do not operate at boom lengths, radii, or boom angle, where no capacities are shown. Crane may overturn without any load on the hook.
9. When boom length is between values listed, refer to the rated lifting capacities of the next longer and next shorter booms for the same radius. The lesser of the two rated lifting capacities shall be used.

10. When making lifts at a load radius not shown, use the next longer radius to determine allowable capacity.
11. Load per line should not exceed 12,300 lbs. (5,600kg) for main winch and auxiliary winch.
12. Check the actual number of parts of line with LOAD MOMENT INDICATOR (AML-L) before operation. Maximum lifting capacity is restricted by the number of parts of line of LOAD MOMENT INDICATOR (AML-L). Limited capacity is as determined from the formula, Single line pull for main winch (12,300 lbs.) x number of parts of line.
13. The boom angle before loading should be greater to account for deflection. For rated lifting capacities, the loaded boom angle and the load radius is for reference only.
14. The 37.7' (11.5m) boom length capacities are based on boom fully retracted. If not fully retracted [less than 51' (15.56m) boom length, use the rated lifting capacities for the 51' (15.56m) boom length.
15. Extension or retraction of the boom with loads may be attempted within the limits of the RATED LIFTING CAPACITIES. The ability to telescope loads is limited by hydraulic pressure, boom angle, boom length, crane maintenance, etc.
16. For lifting capacity of single top, reduce the rated lifting capacities of relevant boom according to a weight reductions for auxiliary load handling equipment. Capacities of single top shall not exceed 12,300 lbs. (5,600kg) including main hook.
17. When base jib or top jib or both jib removing, jib state switch select removed.
18. When erecting and stowing jib, be sure to retain it by hand or by other means to prevent its free movement.
19. Use "ANTI-TWO BLOCK" disable switch when erecting and stowing jib and when stowing hook block. While the switch is pushed, the hoist does not stop, even when overwind condition occurs.
20. For boom length with 32.5' (9.9m) jib, rated lifting capacities are determined by loaded boom angle only in the column headed "144.4' (44.0m) boom + 32.5' (9.9m) jib".
For boom length with 58.1' (17.7 m) jib, rated lifting capacities are determined by loaded boom angle only in the column headed "144.4' (44.0m) boom + 58.1' (17.7m) jib".
For angles not shown, use the next lower loaded boom angle to determine allowable capacity.
21. When lifting a load by using jib (aux. winch) and boom (main winch) simultaneously, do the following:
 - Enter the operation status as jib operation, not as boom operation.
 - Before starting operation, make sure that mass of load is within rated lifting capacity for jib.

DEFINITIONS

1. Load Radius: Horizontal distance from a projection of the axis of rotation to supporting surface before loading to the center of the vertical hoist line or tackle with load applied.
2. Loaded Boom Angle: The angle between the boom base section and the horizontal, after lifting the rated lifting capacity at the load radius.
3. Working Area: Area measured in a circular arc about the centerline of rotation.
4. Freely Suspended Load: Load hanging free with no direct external force applied except by the hoist line.
5. Side Load: Horizontal side force applied to the lifted load either on the ground or in the air.

GR-800XL-1 RATED LIFTING CAPACITIES (IN POUNDS)

ON RUBBER													TIRE : 29.5-25 22PR					
A	Stationary									Creep								
	OVER FRONT						360° ROTATION			OVER FRONT								
	37.7'		64.4'		91'		37.7'		64.4'	91'	37.7'		64.4'		91'			
B	C	(11.5m)	C	(19.62m)	C	(27.75m)	C	(11.5m)	C	(19.62m)	C	(27.75m)	C	(11.5m)	C	(19.62m)	C	(27.75m)
10	68	71,200					68	49,500			68	55,200						
12	65	62,200					65	41,700			65	47,800						
15	59	51,600					59	29,400			59	39,200						
20	50	39,400	69	35,300			50	18,000	69	21,300			50	29,000	69	31,900		
25	38	28,000	64	29,400			38	11,600	64	14,700			38	22,200	64	25,200		
30	21	20,300	59	23,600	69	22,100	21	7,600	58	10,600	69	10,600	21	17,200	59	20,200	69	21,200
35			53	18,100	66	19,100			53	7,500	65	7,800			53	16,500	66	17,500
40			47	14,300	62	15,300			47	5,300	62	5,800			47	13,500	62	14,600
45			40	11,200	59	12,400			40	3,600	58	4,200			40	11,100	59	12,200
50			32	9,000	55	10,000			32	2,300	54	3,000			32	9,000	55	10,000
55			21	7,100	50	8,200			21	1,200	50	2,100			21	7,100	50	8,200
60					46	6,600					45	1,300					46	6,600
65					41	5,400											41	5,400
70					36	4,300											36	4,300
75					29	3,400											29	3,400
80					22	2,700											22	2,700
D	0°						0°		21°		45°		0°					
Telescoping conditions (%)																		
Telescoping mode	I, II		II		II		I, II		II		II		I, II		II		II	
2nd boom	0		0		0		0		0		0		0		0		0	
3rd boom	0		33		66		0		33		66		0		33		66	
4th boom	0		33		66		0		33		66		0		33		66	
Top boom	0		33		66		0		33		66		0		33		66	

LIFTING CAPACITIES AT ZERO DEGREE BOOM ANGLE ON RUBBER OPERATION															
A	Stationary									Creep					
	OVER FRONT						360° ROTATION			OVER FRONT					
	37.7'		64.4'		91'		37.7'			37.7'		64.4'		91'	
C	B	(11.5m)	B	(19.62m)	B	(27.75m)	B	(11.5m)		B	(11.5m)	B	(19.62m)	B	(27.75m)
0°	31.7	18,600	58.3	6,000	85.0	1,900	31.7	6,600		31.7	16,100	58.3	6,000	85.0	1,900

- A : Boom length in feet
- B : Load radius in feet
- C : Loaded boom angle (deg.)
- D : Minimum boom angle (deg.) for indicated length (no load)

NOTE: -The lifting capacity data stored in the LOAD MOMENT INDICATOR (AML-L) is based on the standard number of parts of line listed in the chart.
 -Standard number of parts of line for rubber operation should be according to the following table.

Boom Length in Feet (meters)	37.7' (11.5m)	37.7' to 91' (11.5m to 27.75m)	Single top Jib
Number of parts of line	7	4	1

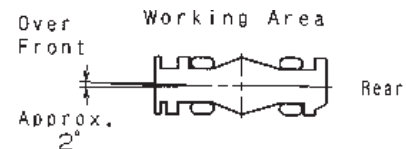

WARNING AND OPERATING INSTRUCTIONS FOR ON RUBBER LIFTING CAPACITIES

- Rated lifting capacities on rubber are in pounds and do not exceed 75 % of tipping loads as determined by SAE J765-Crane Stability Test Code.
- Rated lifting capacities shown in the chart are based on condition that crane is set on firm level surfaces with axle oscillation lockout applied. Those above bold lines are based on tire capacity and those below, on crane stability. They are based on actual load radius increased by tire deformation and boom deflection.
- If the axle oscillation lockout cylinders contain air, the axle will not be locked completely and rated lifting capacities may not be obtainable. Bleed the cylinders according to the operation safety and maintenance manual.
- Rated lifting capacities are based on proper tire inflation, capacity and condition. Damaged tires are hazardous to safe operation of crane.
- Tires shall be inflated to correct air pressure.
- Over front operation shall be performed within two degrees in front of chassis.
- On rubber lifting with "jib" is not permitted. Maximum permissible boom length is 87 ft. (26.52m).
- When making lift on rubber stationary, set parking brake.
- For creep operation, boom must be centered over front of machine, swing lock engaged, and load restrained from swinging. Travel slowly and keep the lifted load as close to the ground as possible, and especially avoid any abrupt steering, accelerating or braking.
- Do not operate the crane while carrying the load.
- Creep is motion for crane not to travel more than 200 ft. (60 m) in any 30 minute period and to travel at the speed of less than 1mph (1.6km/h).
- For creep operation, set Drive select switch to "4-WHEEL (Lo)" and set gear shift lever to "1".

Tires	Air Pressure
29.5-25 22PR	60 psi (4.2 kgf/cm ²)

WARNING AND OPERATING INSTRUCTIONS FOR USING THE LOAD MOMENT INDICATOR (AML-L)

1. When operating crane on outriggers:

Set P.T.O. switch to "ON".

Press the outrigger mode select key to register for the outrigger operation. Press the set key, then the outrigger mode indicative symbol changes from flickering to lighting. Press the boom mode select key to register the boom mode, then the boom mode indicative symbol changes from lighting to flickering. Each time the boom mode select key is pressed, the mode changes. Press the set key to select the status that corresponds to the actual state of the boom, then the boom mode indicative symbol changes from flickering to lighting.

When erecting and stowing jib, select the status of jib set (jib state indicative symbol flicker).

2. When operating crane on rubber:

Set P.T.O. switch to "ON".

Press the outrigger mode select key. The on-tire mode indicative symbol comes on. Each time the outrigger mode select key is pressed the mode changes. Select the creep operation, the on-tire mode indicative symbol flicker.

Press the boom mode select key to register the boom mode.

However, pay attention to the following.

(1) For stationary operation.

The front capacities are attainable only when the over front position symbol comes on. When the boom is more than 2 degrees from centered over front of chassis, 360° capacities are in effect.

When a load is lifted in the front position and then swung to the side area, make sure the value of the LOAD MOMENT INDICATOR(AML-L) is below the 360° lifting capacity.

(2) For creep operation.

The creep capacities are attainable only when boom is in the straight forward position of chassis and the over front position symbol is on. If boom is not in the straight forward position of chassis, never lift load.

3. A swing does not automatically stop even if the crane becomes overloaded.
4. During crane operation, make sure that the displays on front panel are in accordance with actual operating conditions.
5. The displayed values of LOAD MOMENT INDICATOR (AML-L) are based on freely suspended loads and make no allowance for such factors as the effect of wind, sudden stopping of loads, supporting surface conditions, inflation of tire, operating speed, side loads, etc.
For safe operation, it is recommended when extending and lowering boom or swinging, lifting loads shall be appropriately reduced.
6. LOAD MOMENT INDICATOR (AML-L) is intended as an aid to the operator. Under no condition should it be relied upon to replace use of capacity charts and operating instruction. Sole reliance upon LOAD MOMENT INDICATOR (AML-L) aids in place of good operating practice can cause an accident. The operator must exercise caution to assure safety.

GR-800XL-1 Axle weight distribution chart

	Pounds			Kilograms		
	GVW	Front	Rear	GVW	Front	Rear
Base machine	107,965	57,781	50,185	48,972	26,209	22,763
Remove:						
1. 80 ton (72.6 metric ton) hook block	-1,817	-3,276	1,459	-824	-1,486	662
2. 6.2 ton (5.6 metric ton) hook ball	-289	-401	112	-131	-182	51
3. Hot water cab heater and air conditioner	-214	-68	-146	-97	-31	-66
4. Top jib (25.6')	-677	-880	203	-307	-399	92
5. Base jib (32.5')	-1,832	-3,543	1,711	-831	-1,607	776
6. Auxiliary lifting sheave	-110	-324	214	-50	-147	97
7. Removable Counterweight	-17,355	7,474	-24,828	-7,872	3,390	-11,262

