

GENERAL DATA

CRANE CAPACITY	120t at 3.0m
BOOM	5-section, 12.8 m – 47.2 m
DIMENSION	
Overall Length	15.8 m
Overall Width (tracks extended)	5.8 m
Overall Width (tracks retracted)	3.66 m
Overall Width (tracks removed)	2.97 m
Overall Height (working)	4.5 m
MASS	
Gross Vehicle Mass (Standard Equipment Package)	117,931 kg
Maximum Counterweight	Upper = 31750 kg Carbody = 9070 kg
PERFORMANCE	
Travel Speed	0.8 km/hr/ 2.6 km/hr
Gradability	52%

CRANE SPECIFICATION

MODEL	CAPACITY
GTC-1200	120t at 3.0m

BOOM

5-section full power telescoping boom with 2 extension modes. System consists of three double acting hydraulic cylinders with load holding valves and extension and retraction cables.

- Retracted Length: 12.8m
- Extended Length: 47.2 m
- Extension Time: 170 s
- Elevating Angles: -2° to 82°
- Elevating Time: 89 s
- Boom Head: Eight, 543 mm diameter cast nylon sheaves on heavy-duty roller bearings (6 load bearing and 2 lead in sheaves). Designed for quick reeving of head and load block.

AUXILIARY BOOM HEAD

Quick reeve, single 543 mm diameter high-strength, cast nylon sheave mounted on a heavy-duty roller bearing. Allows single or 2 part reeving.

TRAVEL

Each side frame contains a pilot controlled, two-speed track drive with hydraulic axial piston motor and parking brake. Travel system provides skid steering and counter rotation.

- Low travel speed: 0.8 km/h
- High travel speed: 2.6 km/h
- Gradeability (unladen): 52%

COUNTERWEIGHT

5 piece counterweight design.

Three upper counterweight configurations

- “A” Configuration = 10590 kg
- “B” Configuration = 21180 kg
- “C” Configuration = 31750 kg
- Two carbody counterweights, 4535kg each

WINCHES

Planetary geared two-speed winch includes a hydraulic motor, multi-disc internal brake, counterbalance valve, grooved drum, cable follower, and 3rd wrap indicator. Drum rotation indicator is included (complete winch performance specs on Page 3)

- Main Winch
 - o Rope Diameter and Length: 22mm x 231m
 - o Single line pull: 104.8 kN (first layer)
 - o Single line speed: 89.4 m/min (5th layer)
- Auxiliary Winch
 - o Rope Diameter and Length: 22mm x 187m
 - o Single line pull: 104.8 kN (first layer)
 - o Single line speed: 96.7 m/min (5th layer)

SWING

Closed loop hydrostatic transmission with electronic displacement controlled piston pump. Operator selectable modes allow for either free swing with counter-swing or closed loop swing. Swing motor drives planetary gear reducer with a shaft mounted pinion, external gear shear ball slew bearing bolted to the superstructure and the carbody allows the superstructure to rotate 360°.

- Swing Speed: 0 - 1.8 rpm
- Swing Parking Brake: Spring applied failsafe brake with hydraulic release that is controlled from the operators cab
- Swing Service Brake: Hydraulically applied, controlled through foot actuated pedal
- House Lock Systems:
 - o 4-position house lock (boom over front, rear or either side). Actuated from the operator's cab.
 - o 360 degree house lock. Actuated from the operator's cab.

TELEMATICS

Machine data logging and monitoring system with HELLO-NET via Internet.

LOAD MOMENT INDICATOR

TADANO AML-C Rated Capacity Limiter and Anti-Two Block system

- Control function shutdown. Audible and visual warnings
- LCD screen provides a continuous display of working boom length, boom angle, working load radius, tip height, swing position, parts-of-line (operator set), machine track configuration, relative load moment, maximum permissible load and actual load.
- Anti-two block weight allows quick reeving of hook block
- Operator configurable working range limits with automatic soft stop.

FRAME

The frame is an all-steel, welded structure, precision machined to accept attachment of the boom and swing components.

OPERATORS CAB

Fully-enclosed, air conditioned all-steel modular cab with lockable sliding door, acoustical lining, anti-slip floor and tinted safety glass.

- Cab tilts 20°.
- Rear view cameras are appropriately located as are three remote control work lights.
- Vent window in the rear of the cab.
- Grab bars and steps are located for easy access to the cab.
- Defroster, heater, circulating fan
- 2-speed windshield wiper, top glass wiper
- Six-way adjustable fabric seat with headrest, seat belt
- Dome light
- Dry-chemical fire extinguisher
- Four-way electronic armrest mounted joysticks control swing, main winch, auxiliary winch. and boom hoist. Hydraulic foot pedals control the travel, boom extend, and swing service brake functions.
- Selectable modes for Fine Control and Travel (using hand control for crane travel)
- Seat termination switch immediately disable all hydraulic functions as the operator rises from the seat. Functions can also be disabled by switch on console.
- Dash instrumentation: tachometer, hour meter, fuel gauge, and DEF level gauge. Indicators are provided for crane level, swing position, load moment, drum rotation, air filter restriction, engine oil temperature and pressure, hydraulic oil temperature and level, and hydraulic and air filter restriction, and low voltage.

ENGINE

- Make/ Model: Cummins QSL
- Max. Output: 350 hp (261 kW) @ 2100 RPM
- Piston Disp: 8.9 L
- Type: 6 Cylinder, Water cooled, 4 Cycle
- Aspiration: Turbocharged and Aftercooled
- Alternator: 70 amp
- Emission Cert: U.S. EPA Tier 3, Euromot Stage IIIA
- Max Torque: 1,519 Nm (1,120Lb-ft) @ 1500 RPM
- Emission Cert: U.S. EPA Tier 4f, Euromot Stage IV
- Max Torque: 1,628 Nm (1,201Lb-ft) @ 1500 RPM

ELECTRICAL SYSTEM

24 VDC

FUEL SYSTEM

- Capacity: 473 liter
- Filtration: Inline fuel/water separator and engine mounted fuel filter

SIDE FRAMES

Two welded steel side frames are paired with a track group. The side frames extend and retract hydraulically and are controlled from the cab.

- Track Rollers: Two top and fourteen bottom sealed rollers on each track frame Idler: Oil filled, self lubricating with nitrogen type tensioner
- Track Shoes: 900 mm, 3-bar semi grouser

HYDRAULIC SYSTEM

- Hydraulic Pumps: Two high pressure, variable axial piston pumps with load sense and power limiting control for crane functions. One axial piston pump for swing function.
- Directional Valves: Multiple pressure and flow compensated valves with integrated relief valves controlled by electrical signals.
- Pump output: 840 l/min @ 2100 RPM engine speed. 345 bar maximum pressure
- Reservoir: 1385 liter capacity, filler breather cap, sight gauge, cleanout, and sump drain.
- Filtration: Three 5 micron, full flow tank mounted return filters with electrical clogging indicator. 2 micron pilot oil in-line pressure filter
- Diagnostic Ports Provided for system, load sense, and pilot pressure

OPTIONAL EQUIPMENT

- Jibs
 - o Heavy lift jib:
 - Total Length: 3.8m
 - Max. Lifting Height: 46.5 m
 - Offset Angles: 20° & 40°
 - o Main jib:
 - Total Length: 10.2m
 - Max. Lifting Height: 57.2 m
 - Offset Angles: 20° & 40°
 - o Fly jib:
 - Total Length: 18.0m
 - Max. Lifting Height: 65.1 m
 - Offset Angles: 20° & 40°
 - o Long jib:
 - Total Length: 32.0m
 - Max. Lifting Height: 79.0 m
 - Offset Angles: 20° & 40°
- Hook blocks
 - o 120t hook block – Six 457 mm steel sheaves, swivel hook & safety latch
 - o 64t hook block – Three 457 mm steel sheaves, swivel hook & safety latch
 - o 25t hook block – One 457 mm steel sheave, swivel hook & safety latch
- Overhaul ball – 12.5t with swivel hook & safety latch
- Track Shoes: 900 mm flat shoe
- Tool Circuit: Provides 23 l/min and 45 l/min at 176 bar through a 15.2m twin hose reel with quick disconnect fittings to operate open center tools.
- High Flow Tool Circuit: Provides 170 l/min at 330 bar
- Free Fall Hoists: Winches are available in controlled free fall configurations.
- Cold Weather Packages: Cold weather options are available for operation to -40°C (Consult factory for application support)
- Work Platform: Model WP750 – 0.9m x 1.8m, all steel, welded, two person platform with maximum capacity of 340 kg.
- Radio control package.
- FOPS

MAIN WINCH AND AUXILIARY WINCH PERFORMANCE

Wire Rope:22 mm diameter rotation resistant. Line pulls are not based on wire rope strength.

Rope Layer	Maximum Line Pull (kN)	No Load Line Speed (m/min)	Full Load Line Speed (m/min)	Pitch Diameter (mm)	Layer (m)	Total (m)
1	104.8	67.1	39.9	479.1	37.6	37.6
2	95.6	72.7	43.2	518.9	40.8	78.4
3	87.9	78.3	46.6	558.7	43.9	122.3
4	81.3	83.8	49.9	598.4	47.0	169.3
5	75.6	89.4	53.2	638.2	50.1	219.4
6	70.7	95.0	56.5	678.0	53.2	272.6

MACHINE WEIGHTS

KG

Standard Crane with 5 section - 47.2m boom, full counterweight, auxiliary winch with wire rope and 900mm 3-bar semi grouser track shoes	117,931
Standard Crane with 5 section 47.2m boom, auxiliary winch with wire rope (Counterweight and track frames removed)	48,292
Standard Crane with auxiliary winch with wire rope (47.2m boom, boom hoist cylinder , counterweight and track frames removed)	31,976

OPTIONAL EQUIPMENT

Heavy Lift Jib - 3.8 m	1040
Main Jib - 10.2 m	1494
Full Jib - 18.0m	1946
Lattice Jib Insert - 2 Pieces, 7.14m each	954
Auxiliary Nose Sheave	135
120t hook block - six sheave	1024
64t hook block - three sheave	588
25t hook block - one sheave	398
12.5t Overhaul Ball	199

GTC-1200

120t Telescopic Boom Crawler Crane

SPECIFICATION SHEET NO. TMC-DI-734-02-002-07/15-ISO

DIMENSIONS

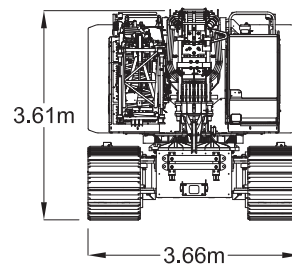
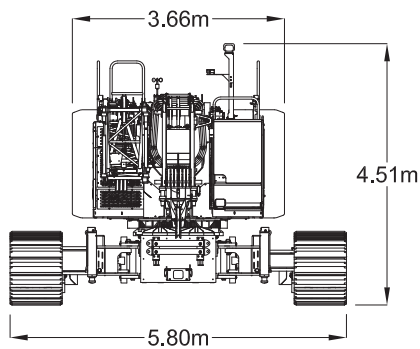
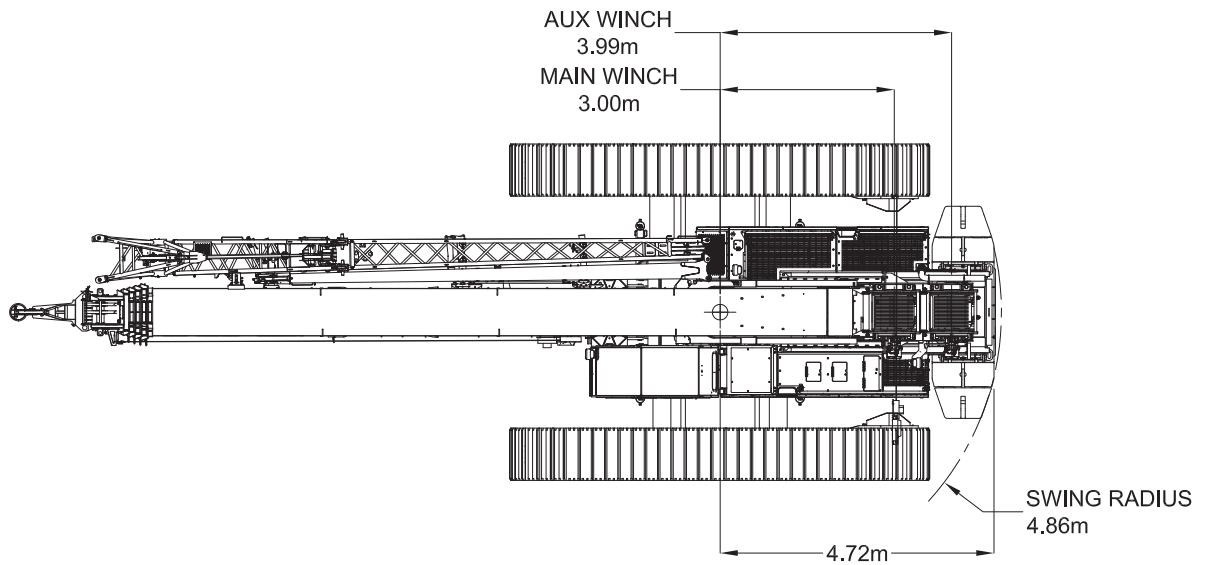
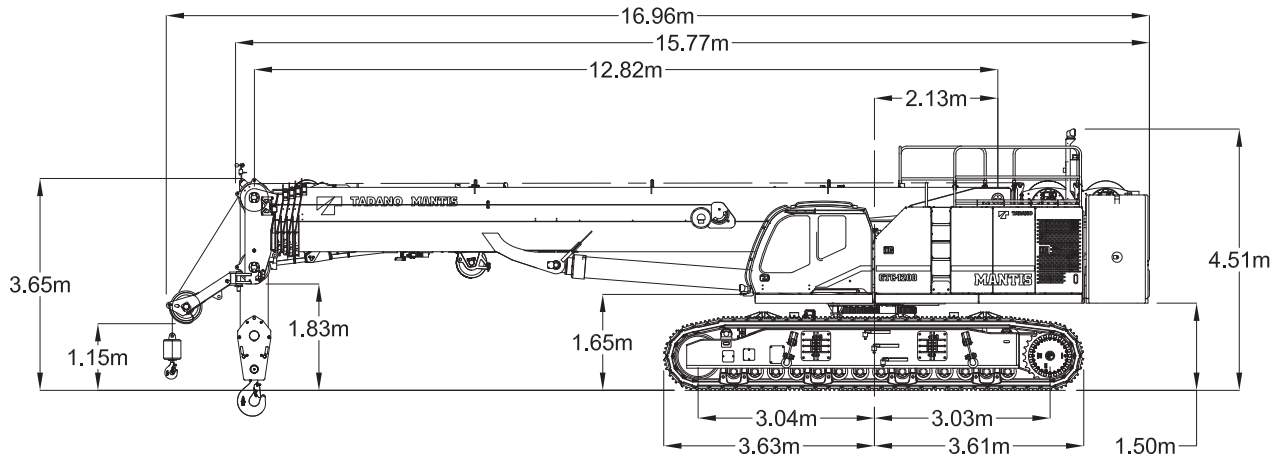

TRANSPORT DIMENSIONS

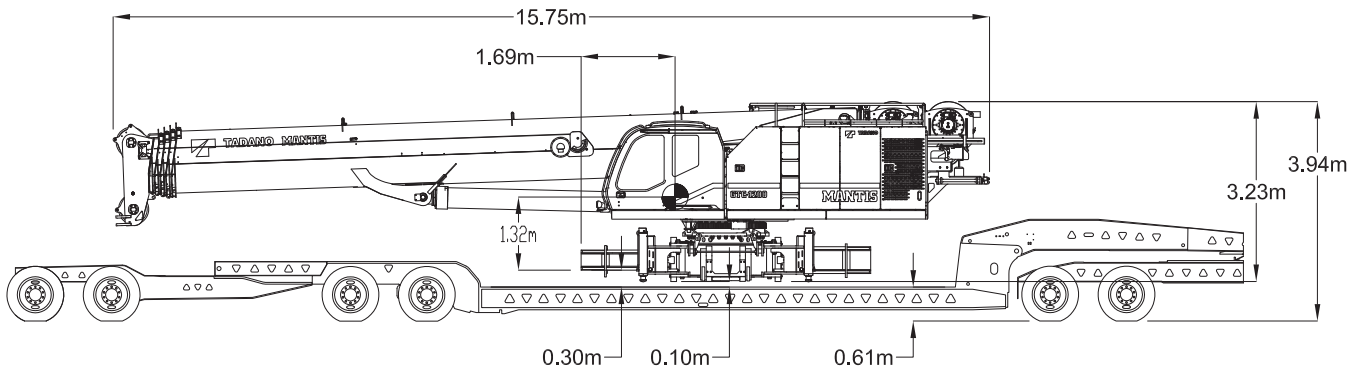

Track frame assembly
13,710 kg each

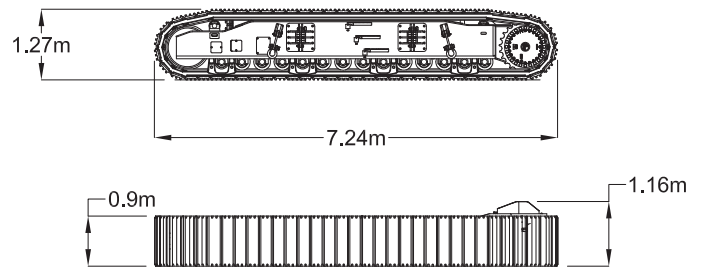

TRANSPORT PLAN

Item	Weight Kg	Dimensions (L x W x H)	Trailer				
			1	2	3	4	5
Crane Transporter (with 2 winches, Boom, wire rope)	48,292	15.75m x 3.0m x 3.25m	X				
Left Track Frame	13,710	7.27m x 1.17m x 1.27m		X			
Right Track Frame	13,710	7.27m x 1.17m x 1.27m			X		
Counterweight A	10,590	1.22m x 2.79m x 1.24m				X	
Counterweight B - 1 piece	5,300	2.44m x 1.07m x 0.50m		X			
Counterweight B - 1 piece	5,300	2.44m x 1.07m x 0.50m			X		
Counterweight C - 1 piece	5,300	1.88m x 0.99m x 0.86m					X
Counterweight C - 1 piece	5,300	1.88m x 0.99m x 0.86m					X
Counterweight - Carbody - 1 piece	4,535	0.96m x 1.30m x 0.81m				X	
Counterweight - Carbody - 1 piece	4,535	0.96m x 1.30m x 0.81m				X	
Jib - Heavy lift	1,040	4.42m x 0.84m x 1.52m					X
Jib base section	454	6.40m x 0.71m x 1.04m					X
Jib point	452	7.80m x 0.46m x 0.69m					X
Jib Insert	477	7.14m x 0.66m x 1.02m					X
Jib Insert	477	7.14m x 0.66m x 1.02m					X
Auxiliary Nose Sheave	135	1.24m x 0.64m x 0.89m					X
Hook Block - 120t	1,024	1.73m x 0.58m x 0.58m					X
Headache Ball - 12.5t	199	0.81m x 0.30m x 0.30m			X		
Miscellaneous Items (Crate)	226	1.22m x 0.91m x 0.91m					X
Total Net Weight on Trailer (kg)			48,292	19,010	19,210	19,660	14,885

TRANSPORT DIMENSIONS - COUNTERWEIGHT

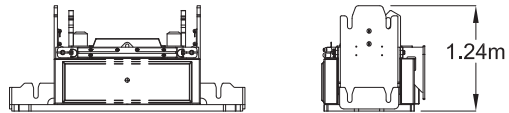
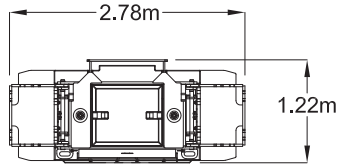

Configuration "A"
Weight: 10,590 kg

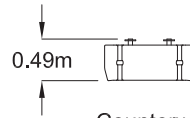
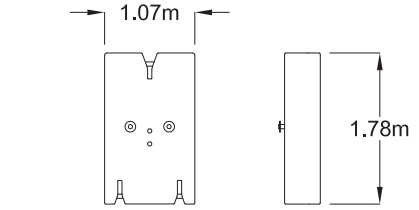

Counterweight Segment "B"
2 Pieces
Weight: 5,300 kg each

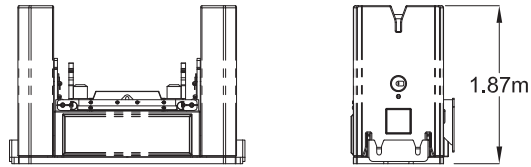
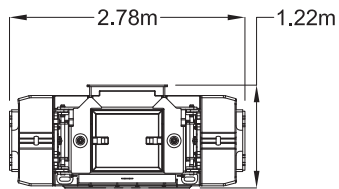

Configuration "B"
Weight: 21,180 kg

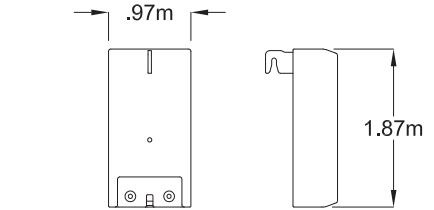

Counterweight Segment "C"
2 Pieces
Weight: 5,300 kg each

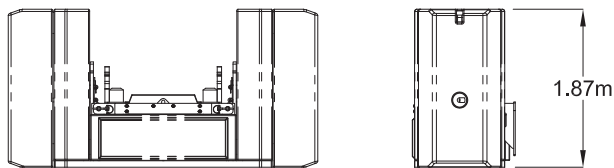
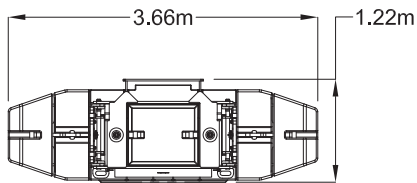

Configuration "C"
Weight: 31,750 kg

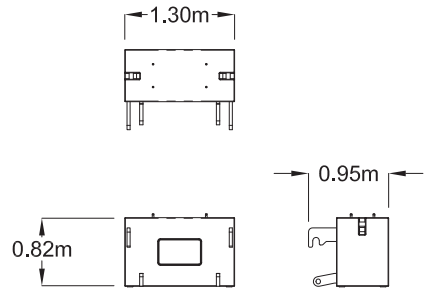

Carbody Counterweight
2 Pieces
Weight: 4,535 kg each

TRANSPORT DIMENSIONS - OPTIONAL LIFTING ATTACHMENTS

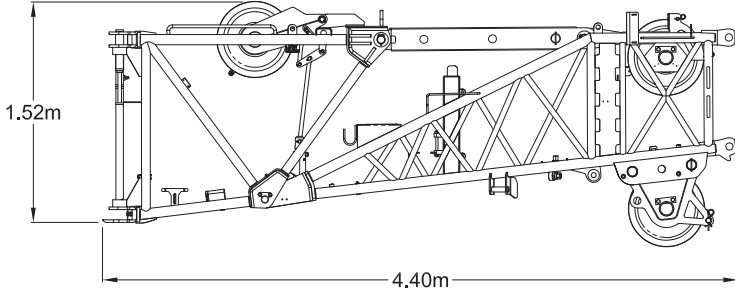

Heavy Lift Jib
Weight: 1,040 kg

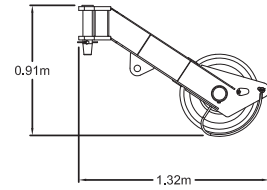

Auxiliary Nose Sheave
Weight: 135 kg

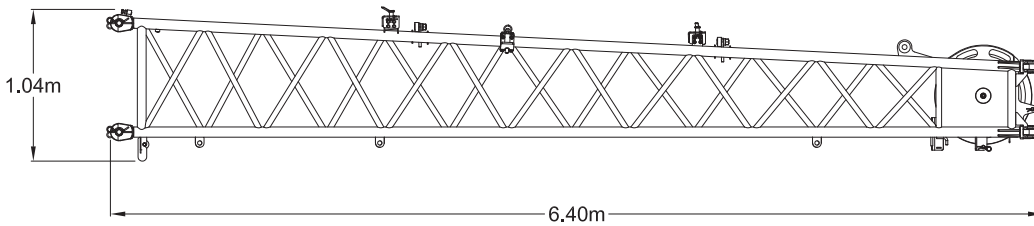

Main Jib
Weight: 454 kg

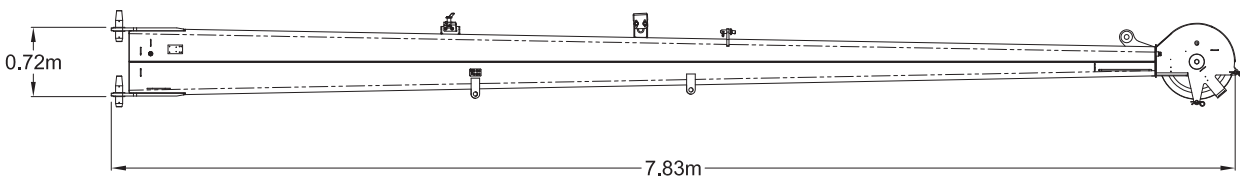

Fly Jib
Weight: 452 kg

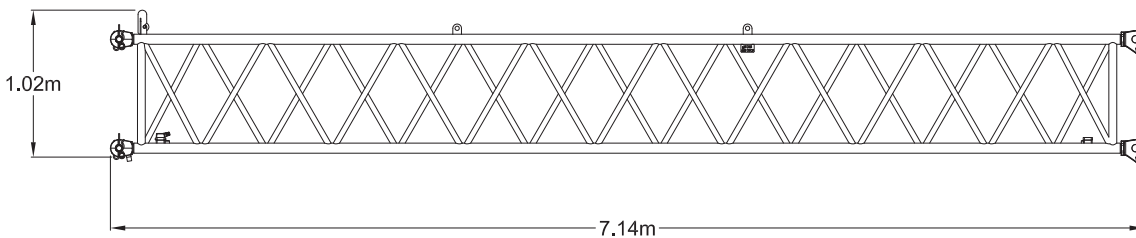

Lattice Jib Insert
Weight: 477 kg

WORKING RANGE DIAGRAM

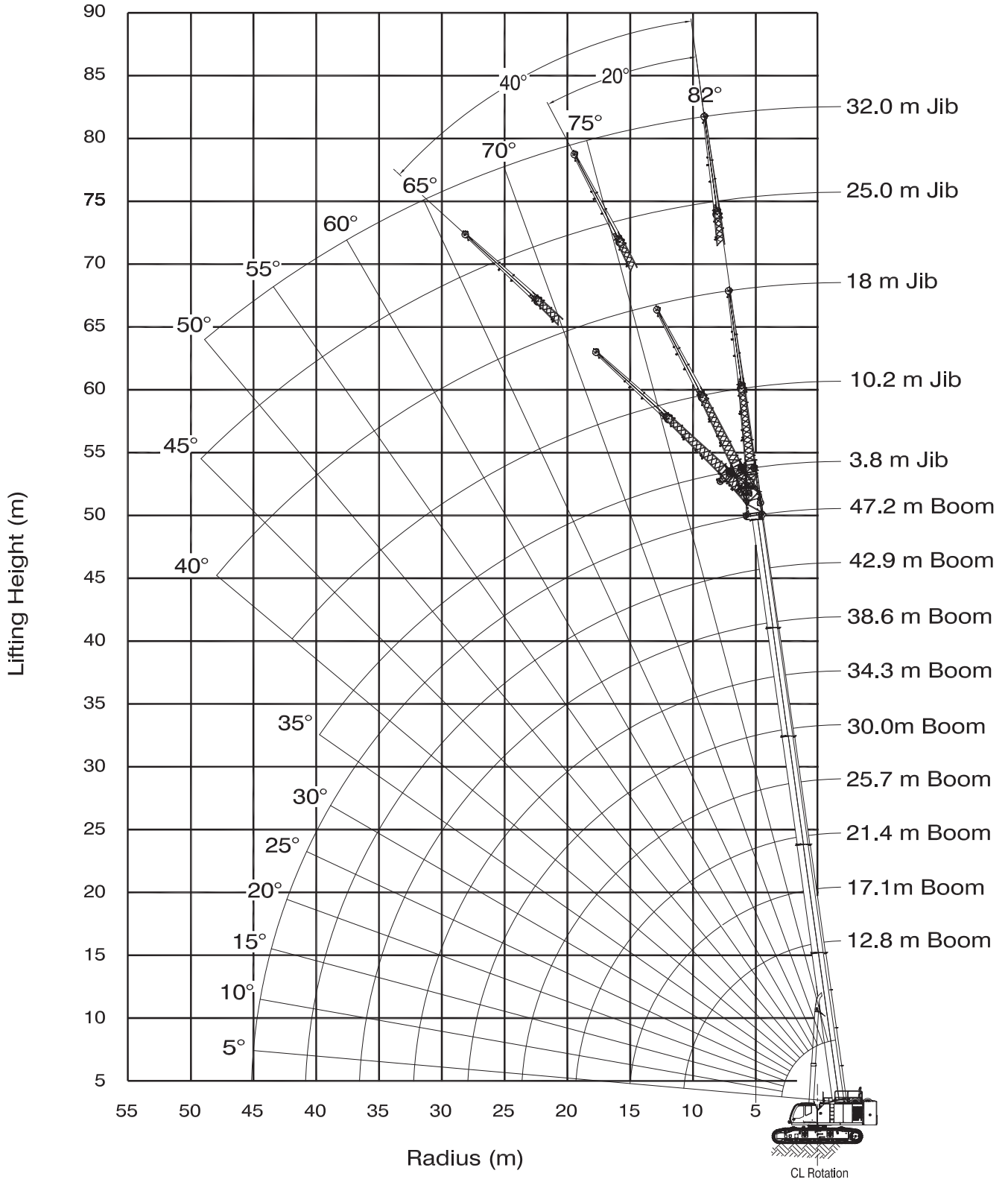

LOAD CHARTS

360 DEGREE RATING - LOADS IN kg x 1000

MAIN BOOM with TRACKS EXTENDED - 360° NO TRAVEL - LEVEL 0° to 1.5° 31.8 t MAIN COUNTERWEIGHT AND 9.0 t CARBODY COUNTERWEIGHT										
RADIUS (m)	MAIN BOOM LENGTH (m)									RADIUS (m)
	12.8	17.1	21.4	25.7	30	34.3	38.6	42.9	47.2	
3	120	76.5	68.6							3
4	103.8	76.5	66.9	55.2						4
5	90.4	76.5	60.3	50.1	42.3	27.5				5
6	75.9	74.9	54.5	45.6	38.9	29.5	23.3			6
7	63.8	62	49.7	41.6	35.8	29.5	27.7			7
8	54.7	52.6	45.7	38.2	33.1	29.4	26.1	22.4		8
9	45.6	44.2	42.1	35.2	30.6	27.6	24.6	21.9	17.6	9
10	39	37.7	36.7	32.5	28.4	25.7	23.2	20.9	17.5	10
12		28.6	27.9	26.2	24.6	22.6	20.7	18.8	16.3	12
14		22.7	22	22.6	19.7	19.9	18.5	17	15.1	14
16			17.8	18.4	17.2	16.3	16.6	15.4	14	16
18			14.7	15.3	15.3	13.6	13.8	14	12.8	18
20				12.9	13.2	12.2	11.4	11.9	11.7	20
22				11	11.3	11	10	10.9	10.3	22
24					9.8	10	9	9.4	8.8	24
26					8.5	8.8	8.2	8.1	7.5	26
28						7.7	7.5	7	6.4	28
30						6.8	6.9	6.1	5.5	30
32						6	6.1	5.3	4.7	32
34							5.4	4.6	4	34
36							4.9	4	3.3	36
38								3.4	2.8	38
40								3	2.3	40
42									1.9	42
44									1.5	44
PARTS OF LINE	12	9	8	6	6	4	4	4	2	PARTS OF LINE

Load chart data is for reference, load charts supplied in the crane cab shall be used for lift planning.

LOAD CHARTS

360 DEGREE RATING - LOADS IN kg x 1000

MAIN BOOM with TRACKS RETRACTED - OVER FRONT/REAR										
NO TRAVEL - LEVEL 0° to 1.5°										
31.8 t MAIN COUNTERWEIGHT AND 9.0 t CARBODY COUNTERWEIGHT										
RADIUS (m)	MAIN BOOM LENGTH (m)									RADIUS (m)
	12.8	17.1	21.4	25.7	30	34.3	38.6	42.9	47.2	
3	120	76.5	68.6							3
4	103.8	76.5	66.9	55.2						4
5	90.4	76.5	60.3	50.1	42.3	27.5				5
6	75.9	75.8	54.5	45.6	38.9	29.5	23.3			6
7	63.8	63.8	49.7	41.6	35.8	29.5	27.7			7
8	54.8	54.7	45.7	38.2	33.1	29.4	26.1	22.4		8
9	47.7	47.6	42.3	35.2	30.6	27.6	24.6	21.9	17.6	9
10	42.1	42	38.8	32.5	28.4	25.7	23.2	20.9	17.5	10
12		32.3	31.5	28.1	24.7	22.6	20.7	18.8	16.3	12
14		25.6	24.8	22.9	21.6	19.9	18.5	17	15.1	14
16			20.1	20.2	17.9	17.6	16.6	15.4	14	16
18			16.7	17.3	15.3	15.2	14.7	14	12.8	18
20				14.6	13.8	12.6	13	12.5	11.7	20
22				12.5	12.5	11	11	11.1	10.5	22
24					11.1	10	9.3	10.1	9.4	24
26					9.7	9.1	8.2	9.2	8.4	26
28						8.4	7.5	8.1	7.5	28
30						7.7	6.9	7.1	6.5	30
32						7	6.4	6.2	5.6	32
34							5.9	5.4	4.8	34
36							5.5	4.8	4.2	36
38								4.2	3.6	38
40								3.7	3	40
42									2.6	42
44									2.1	44
PARTS OF LINE	12	9	8	6	6	4	4	4	2	PARTS OF LINE

Load chart data is for reference, load charts supplied in the crane cab shall be used for lift planning.

LOAD CHARTS

360 DEGREE RATING - LOADS IN kg x 1000

MAIN BOOM with TRACKS RETRACTED OVER SIDE										
NO TRAVEL - LEVEL 0° to 1.5°										
31.8 t MAIN COUNTERWEIGHT AND 9.0 t CARBODY COUNTERWEIGHT										
RADIUS (m)	MAIN BOOM LENGTH (m)									RADIUS (m)
	12.8	17.1	21.4	25.7	30	34.3	38.6	42.9	47.2	
3	*	*	*							3
4	*	*	*	*						4
5	*	*	*	*	*	*				5
6	*	*	*	*	*	*	*			6
7	37.9	35.7	32.8	*	*	*	*			7
8	31.3	30.4	28.2	27.4	*	*	*	*		8
9	26.4	25.6	24.5	24.1	23.4	*	*	*	*	9
10	22.7	21.9	21.3	21.3	20.8	20.3	18.7	18	16.5	10
12		16.6	16.1	16.7	16.8	16.5	16.2	14.6	13.3	12
14		12.9	12.4	13.1	13.5	13.7	13.5	12.1	10.9	14
16			9.8	10.5	10.9	11.2	11.3	10.1	9	16
18			7.8	8.5	8.9	9.2	9.4	8.4	7.4	18
20				6.9	7.3	7.7	7.8	7	6.1	20
22				5.6	6	6.4	6.6	5.7	5	22
24					5	5.3	5.5	4.7	4.1	24
26					4.1	4.4	4.6	3.8	3.3	26
28						3.7	3.9	3.1	2.5	28
30						3.1	3.2	2.4	1.9	30
32						2.6	2.7	1.9	1.3	32
34							2.2	1.4	*	34
36							1.9	1	*	36
38								*	*	38
40								*	*	40
42									*	42
44									*	44
PARTS OF LINE	12	9	8	6	6	4	4	4	2	PARTS OF LINE

Load chart data is for reference, load charts supplied in the crane cab shall be used for lift planning.

LOAD CHARTS

360 DEGREE RATING - LOADS IN kg x 1000

MAIN BOOM with TRACKS EXTENDED - 360° NO TRAVEL - LEVEL 0° to 1.5°										
0 t MAIN COUNTERWEIGHT AND 9.0 t CARBODY COUNTERWEIGHT										
RADIUS (m)	MAIN BOOM LENGTH (m)									RADIUS (m)
	12.8	17.1	21.4	25.7	30	34.3	38.6	42.9	47.2	
3	113	76.5	68.6							3
4	71.9	60.7	52.4	31.6						4
5	51.7	45	39.7	31.6	30.3	27.5				5
6	39.7	35.1	31.4	29.9	28.3	26.8	23.3			6
7	31.7	28.3	25.5	24.7	23.6	22.6	21.6			7
8	24.9	23.4	21.2	20.7	20.1	19.4	18.6	16.5		8
9	20.2	19.4	17.8	17.7	17.2	16.8	16.2	14.4	12.8	9
10	16.7	16	15.1	15.2	15	14.7	14.3	12.5	11.1	10
12		11.2	10.8	11.4	11.5	11.4	11.2	9.7	8.5	12
14		8.1	7.7	8.5	8.9	9	8.9	7.6	6.5	14
16			5.5	6.3	6.8	7.2	7.2	5.9	4.9	16
18			3.9	4.6	5.1	5.5	5.8	4.6	3.7	18
20				3.4	3.8	4.3	4.5	3.5	2.6	20
22				2.4	2.8	3.2	3.5	2.6		22
24					2	2.4	2.7	1.8		24
26					1.4	1.7	2			26
28						1.1	1.4			28
30										30
32										32
34										34
36										36
38										38
40										40
42										42
44										44
PARTS OF LINE	12	9	8	6	6	4	4	4	2	PARTS OF LINE

Load chart data is for reference, load charts supplied in the crane cab shall be used for lift planning.

LOAD CHARTS

360 DEGREE RATING - LOADS IN kg x 1000

MAIN BOOM with TRACKS EXTENDED - 360° TRAVEL 0 to 1.8 km/hr - LEVEL 0° to 1.5° 31.8 t MAIN COUNTERWEIGHT AND 9.0 t CARBODY COUNTERWEIGHT										
RADIUS (m)	MAIN BOOM LENGTH (m)									RADIUS (m)
	12.8	17.1	21.4	25.7	30	34.3	38.6	42.9	47.2	
3	120	76.5	68.6							3
4	103.8	76.5	66.9	55.2						4
5	90.4	76.5	60.3	50.1	42.3	27.5				5
6	75.9	72.1	54.5	45.6	38.9	29.5	23.3			6
7	63.4	60	49.7	41.6	35.8	29.5	26.1			7
8	51.4	49.8	45.7	38.2	33.1	29.4	26.1	22.4		8
9	42.9	41.6	40.4	35.2	30.6	27.6	24.6	21.9	17.6	9
10	36.7	35.4	34.5	31.7	28.4	25.7	23.2	20.9	17.5	10
12		26.9	26.2	26.2	23.7	22.6	20.7	18.8	16.3	12
14		21.3	20.7	21.2	19.5	19.1	18.5	17	15.1	14
16			16.7	17.3	17.2	15.4	15.7	15.4	14	16
18			13.8	14.4	14.7	13.6	12.9	13.2	12.8	18
20				12.1	12.4	12.2	11.1	11.9	11.4	20
22				10.3	10.6	11	10	10.3	9.7	22
24					9.2	9.5	9	8.8	8.3	24
26					8	8.2	8.2	7.6	7.1	26
28						7.2	7.4	6.6	6	28
30						6.4	6.5	5.7	5.2	30
32						5.7	5.8	4.9	4.4	32
34							5.1	4.3	3.7	34
36							4.6	3.7	3.1	36
38								3.2	2.6	38
40								2.8	2.2	40
42									1.8	42
44									1.4	44
PARTS OF LINE	12	9	8	6	6	4	4	4	2	PARTS OF LINE

Load chart data is for reference, load charts supplied in the crane cab shall be used for lift planning.

LOAD CHARTS

360 DEGREE RATING - LOADS IN kg x 1000

MAIN BOOM with TRACKS RETRACTED - OVER FRONT/REAR TRAVEL 0 to 1.8 km/hr - LEVEL 0° to 1.5° 31.8 t MAIN COUNTERWEIGHT AND 9.0 t CARBODY COUNTERWEIGHT										
RADIUS (m)	MAIN BOOM LENGTH (m)									RADIUS (m)
	12.8	17.1	21.4	25.7	30	34.3	38.6	42.9	47.2	
3	120	76.5	68.6							3
4	103.8	76.5	66.9	55.2						4
5	90.4	76.5	60.3	50.1	42.3	27.5				5
6	75.9	75.8	54.5	45.6	38.9	29.5	23.3			6
7	63.8	63.8	49.7	41.6	35.8	29.5	26.1			7
8	54.8	54.7	45.7	38.2	33.1	29.4	26.1	22.4		8
9	47.7	47.3	42.3	35.2	30.6	27.6	24.6	21.9	17.6	9
10	41.6	40.2	38.8	32.5	28.4	25.7	23.2	20.9	17.5	10
12		30.4	29.6	27.4	24.7	22.6	20.7	18.8	16.3	12
14		24.1	23.3	22.9	21	19.9	18.5	17	15.1	14
16			18.9	19.5	17.2	17.5	16.6	15.4	14	16
18			15.7	16.2	15.3	14.3	14.7	14	12.8	18
20				13.7	13.8	12.2	12.3	12.5	11.7	20
22				11.8	12.1	11	10.4	11	10.5	22
24					10.5	10	9	10.1	9.4	24
26					9.1	9.1	8.2	8.7	8.2	26
28						8.3	7.5	7.6	7.1	28
30						7.3	6.9	6.7	6.1	30
32						6.6	6.4	5.8	5.3	32
34							5.9	5.1	4.5	34
36							5.4	4.5	3.9	36
38								3.9	3.3	38
40								3.5	2.8	40
42									2.4	42
44									2	44
PARTS OF LINE	12	9	8	6	6	4	4	4	2	PARTS OF LINE

Load chart data is for reference, load charts supplied in the crane cab shall be used for lift planning.

LOAD CHARTS

360 DEGREE RATING - LOADS IN kg x 1000

AUX NOSE SHEAVE with TRACKS EXTENDED - 360° NO TRAVEL - LEVEL 0° to 1.5° 31.8 t MAIN COUNTERWEIGHT AND 9.0 t CARBODY COUNTERWEIGHT										
RADIUS (m)	MAIN BOOM LENGTH (m)									RADIUS (m)
	12.8	17.1	21.4	25.7	30	34.3	38.6	42.9	47.2	
3	12.7	12.7	12.7							3
4	12.7	12.7	12.7	12.7						4
5	12.7	12.7	12.7	12.7	12.7					5
6	12.7	12.7	12.7	12.7	12.7	12.7				6
7	12.7	12.7	12.7	12.7	12.7	12.7	12.7			7
8	12.7	12.7	12.7	12.7	12.7	12.7	12.7	12.7		8
9	12.7	12.7	12.7	12.7	12.7	12.7	12.7	12.7	12.7	9
10	12.7	12.7	12.7	12.7	12.7	12.7	12.7	12.7	12.7	10
12		12.7	12.7	12.7	12.7	12.7	12.7	12.7	12.7	12
14		12.7	12.7	12.7	12.7	12.7	12.7	12.7	12.7	14
16			12.7	12.7	12.7	12.7	12.7	12.7	12.7	16
18			12.7	12.7	12.7	12.7	12.7	12.7	12.6	18
20			12.7	12.7	12.7	11.7	11.8	12.1	11.6	20
22				11.3	11.7	10.6	9.9	10.7	10.4	22
24					10.1	9.6	8.7	9.7	8.9	24
26					8.8	8.8	8	8.4	7.6	26
28					7.7	7.9	7.3	7.3	6.6	28
30						7	6.7	6.3	5.6	30
32							6.2	6.2	5.5	32
34								5.6	4.8	34
36								5	4.2	36
38									3.6	38
40									3.2	40
42										42
44										44
PARTS OF LINE	2	2	2	2	2	2	2	2	2	PARTS OF LINE

Load chart data is for reference, load charts supplied in the crane cab shall be used for lift planning.

LOAD CHARTS

360 DEGREE RATING - LOADS IN kg x 1000

AUX NOSE SHEAVE with TRACKS RETRACTED - 360° NO TRAVEL - LEVEL 0° to 1.5° 31.8 t MAIN COUNTERWEIGHT AND 9.0 t CARBODY COUNTERWEIGHT										
RADIUS (m)	MAIN BOOM LENGTH (m)									RADIUS (m)
	12.8	17.1	21.4	25.7	30	34.3	38.6	42.9	47.2	
3	*	*	*							3
4	*	*	*	*						4
5	*	*	*	*	*	*				5
6	*	*	*	*	*	*	*			6
7	*	*	*	*	*	*	*			7
8	12.7	12.7	12.7	12.7	*	*	*	*		8
9	12.7	12.7	12.7	12.7	12.7	*	*	*	*	9
10	12.7	12.7	12.7	12.7	12.7	12.7	*	12.7	12.7	10
12		12.7	12.7	12.7	12.7	12.7	12.7	12.7	12.7	12
14		12.7	12.7	12.7	12.7	12.7	12.7	12.2	11	14
16			10.3	10.9	11.3	11.5	11.5	10.2	9.1	16
18			8.3	8.9	9.3	9.5	9.7	8.6	7.5	18
20			6.7	7.3	7.7	7.9	8.1	7.2	6.3	20
22				6	6.4	6.6	6.8	6	5.2	22
24					5.3	5.6	5.8	5	4.3	24
26					4.4	4.7	4.9	4.1	3.4	26
28					3.7	3.9	4.1	3.3	2.7	28
30						3.3	3.5	2.7	2	30
32						2.7	2.9	2.1	1.5	32
34							2.4	1.6	1	34
36							2	1.2	0.6	36
38								0.8	*	38
40								0.5	*	40
42									*	42
44									*	44
PARTS OF LINE	2	2	2	2	2	2	2	2	2	PARTS OF LINE

Load chart data is for reference, load charts supplied in the crane cab shall be used for lift planning.

LOAD CHARTS

360 DEGREE RATING - LOADS IN kg x 1000

3.8m JIB with TRACKS EXTENDED - 360°																
NO TRAVEL - LEVEL 0° to 1.5°																
31.8 t MAIN COUNTERWEIGHT AND 9.0 t CARBODY COUNTERWEIGHT																
RADIUS (m)	MAIN BOOM LENGTH (m)															RADIUS (m)
	12.8			34.3			38.6			42.9			47.2			
	0	20°	40°	0	20°	40°	0	20°	40°	0	20°	40°	0	20°	40°	
3	40	32.7														3
4	40	30.9	25													4
5	38.6	28.5	24.6													5
6	34.7	26.6	23.6													6
7	31.5	24.9	22.7		15.8											7
8	28.9	23.5	21.9	16.8	15.2	14.1										8
9	26.8	22.3	21.2	15.9	14.5	13.5	14.1	13	12.1							9
10	25	21.3	20.6	15.1	13.8	12.9	13.3	12.3	11.6	12.8	11.9	10.9				10
12	22.1	19.9	19.7	13.7	12.7	11.9	12.1	11.3	10.7	11.7	10.9	10.4	11.2	10.4	9.9	12
14	20.3		19.2	12.4	11.7	11.1	10.9	10.4	9.9	10.8	10.1	9.6	10.3	9.7	9.3	14
16				11.2	10.9	10.4	9.9	9.7	9.3	9.8	9.4	9	9.6	9.1	8.7	16
18				10.2	10.1	9.8	8.9	8.9	8.7	9	8.8	8.5	8.8	8.5	8.2	18
20				9.3	9.2	9.1	8.1	8.1	8.1	8.3	8.2	8	8.1	8	7.7	20
22				8.5	8.4	8.4	7.4	7.4	7.4	7.6	7.5	7.5	7.6	7.5	7.3	22
24				7.8	7.8	7.7	6.8	6.8	6.8	7	7	6.9	7	7	6.9	24
26				7.2	7.2		6.3	6.3	6.3	6.5	6.5	6.4	6.3	6.5	6.5	26
28				6.6	6.6		5.8	5.8	5.8	5.9	6	6	5.2	5.4	5.5	28
30				5.6	5.7		5.2	5.3	5.3	5	5.1	5.2	4.2	4.4	4.5	30
32				4.8	4.9		4.7	4.7		4.2	4.3	4.4	3.4	3.6	3.7	32
34				4.2			4.2	4.3		3.4	3.6		2.7	2.9	3	34
36							3.6	3.7		2.8	2.9		2.1	2.2	2.3	36
38							3.1	3.1		2.3	2.3		1.6	1.7	1.7	38
40							2.7			1.8	1.8		1.1	1.2		40
42										1.3						42
44																44
46																46
48																48
50																50
55																55
60																60
65																65
70																70
75																75
80																80
PARTS OF LINE	6	6	6	3	3	3	2	2	2	2	2	2	2	2	2	PARTS OF LINE

Load chart data is for reference, load charts supplied in the crane cab shall be used for lift planning.

LOAD CHARTS

360 DEGREE RATING - LOADS IN kg x 1000

10.2m JIB with TRACKS EXTENDED - 360°																
NO TRAVEL - LEVEL 0° to 1.5°																
31.8 t MAIN COUNTERWEIGHT AND 9.0 t CARBODY COUNTERWEIGHT																
RADIUS (m)	MAIN BOOM LENGTH (m)															RADIUS (m)
	12.8			34.3			38.6			42.9			47.2			
	0	20°	40°	0	20°	40°	0	20°	40°	0	20°	40°	0	20°	40°	
3	15															3
4	15															4
5	15	14.7														5
6	15	14.4														6
7	15	13.2														7
8	15	12.2	9.3													8
9	15	11.4	9.1	13.4												9
10	14.1	10.6	8.7	13	10.2		11.5									10
12	11.9	9.5	8	11.7	9.6		10.4	8.7		10.1			8.6			12
14	10.3	8.5	7.5	10.6	8.9	7.9	9.4	8.1	6.9	9.2	7.9		8.6	7.6		14
16	9	7.8	7.1	9.7	8.3	7.4	8.6	7.5	6.8	8.5	7.4	6.6	8.5	7.4		16
18	8.1	7.3	6.9	9	7.7	7	8	7	6.4	7.9	6.9	6.3	7.9	7	6.4	18
20	7.3			8.3	7.3	6.6	7.4	6.6	6	7.4	6.5	5.9	7.4	6.6	6	20
22				7.8	6.9	6.3	6.9	6.2	5.7	6.9	6.1	5.6	6.9	6.2	5.7	22
24				7.2	6.5	6	6.4	5.8	5.4	6.4	5.8	5.4	6.4	5.9	5.5	24
26				6.7	6.2	5.8	5.9	5.5	5.2	6	5.5	5.1	6	5.6	5.2	26
28				6.2	5.9	5.5	5.4	5.3	5	5.6	5.3	4.9	5.6	5.4	5	28
30				5.7	5.7	5.4	5	5	4.8	5.2	5	4.7	5	5.1	4.8	30
32				5.2	5.3	5.2	4.6	4.7	4.6	4.7	4.8	4.5	4.2	4.7	4.6	32
34				4.7	4.8	4.9	4.2	4.3	4.4	4	4.5	4.4	3.5	4	4.4	34
36				4.2	4.4		3.8	3.9	4	3.4	3.8	4.1	2.8	3.3	3.6	36
38				3.7	3.9		3.4	3.6		2.9	3.2	3.4	2.3	2.7	3	38
40				3.2			3.1	3.2		2.4	2.7	2.9	1.8	2.2	2.4	40
42							2.8			1.9	2.2	2.3	1.4	1.7	1.9	42
44							2.4			1.5	1.8		1	1.2	1.4	44
46										1.2			0.6	0.8		46
48																48
50																50
55																55
60																60
65																65
70																70
75																75
80																80
PARTS OF LINE	2	2	1	2	1	1	2	1	1	1	1	1	1	1	1	PARTS OF LINE

Load chart data is for reference, load charts supplied in the crane cab shall be used for lift planning.

LOAD CHARTS

360 DEGREE RATING - LOADS IN kg x 1000

18.0m JIB with TRACKS EXTENDED - 360°																
NO TRAVEL - LEVEL 0° to 1.5°																
31.8 t MAIN COUNTERWEIGHT AND 9.0 t CARBODY COUNTERWEIGHT																
RADIUS (m)	MAIN BOOM LENGTH (m)															RADIUS (m)
	12.8			34.3			38.6			42.9			47.2			
	0	20°	40°	0	20°	40°	0	20°	40°	0	20°	40°	0	20°	40°	
3																3
4	6.8															4
5	6.8															5
6	6.8															6
7	6.8															7
8	6.8															8
9	6.8			5.4												9
10	6.7	5.1		5.4												10
12	6	4.7		5.4			5			4.8						12
14	5.3	4.3		5.4			5			4.8			4.5			14
16	4.8	4	3.5	5.4	4.3		5			4.8			4.5			16
18	4.4	3.7	3.2	5.4	4.1		5	4		4.8	4		4.5			18
20	4	3.4	3.1	5.3	3.9	3.2	5	3.9		4.8	3.9		4.5	3.6		20
22	3.7	3.2	2.9	5	3.8	3.2	5	3.8	3	4.8	3.8		4.5	3.6		22
24	3.4	3.1	2.9	4.7	3.6	3.1	4.8	3.6	3	4.8	3.6	3	4.5	3.6	2.7	24
26	3.2	2.9		4.5	3.5	3	4.5	3.5	3	4.6	3.5	3	4.5	3.5	2.7	26
28	3			4.3	3.3	2.9	4.4	3.4	2.9	4.4	3.4	2.9	4.4	3.4	2.7	28
30				4.1	3.2	2.8	4.2	3.2	2.8	4.2	3.3	2.8	4.3	3.3	2.7	30
32				3.9	3.1	2.8	4	3.1	2.8	4.1	3.2	2.8	4.1	3.2	2.7	32
34				3.7	3	2.7	3.8	3.1	2.7	3.9	3.1	2.7	4	3.1	2.7	34
36				3.6	2.9	2.7	3.6	3	2.6	3.8	3	2.7	3.4	3	2.6	36
38				3.4	2.9	2.6	3.3	2.9	2.6	3.5	2.9	2.6	2.8	2.9	2.6	38
40				3.3	2.8	2.6	3	2.8	2.6	3	2.9	2.6	2.3	2.9	2.6	40
42				3.2	2.7		2.7	2.8	2.5	2.5	2.8	2.5	1.9	2.5	2.5	42
44				2.9	2.7		2.5	2.6	2.5	2.1	2.6	2.5	1.5	2.1	2.5	44
46				2.6			2.3	2.4		1.8	2.2	2.5	1.1	1.7	2	46
48				2.3			2.1	2.2		1.4	1.8	2.1	0.8	1.3	1.6	48
50							1.9	2		1.1	1.5	1.7	0.5	0.9		50
55																55
60																60
65																65
70																70
75																75
80																80
PARTS OF LINE	1	1	1	1	1	1	1	1	1	1	1	1	1	1	1	PARTS OF LINE

Load chart data is for reference, load charts supplied in the crane cab shall be used for lift planning.

LOAD CHARTS

360 DEGREE RATING - LOADS IN kg x 1000

32.0m JIB with TRACKS EXTENDED - 360°																
NO TRAVEL - LEVEL																
31.8 t MAIN COUNTERWEIGHT AND 9.0 t CARBODY COUNTERWEIGHT																
RADIUS (m)	MAIN BOOM LENGTH (m)															RADIUS (m)
	12.8			34.3			38.6			42.9			47.2			
	0	20°	40°	0	20°	40°	0	20°	40°	0	20°	40°	0	20°	40°	
6																6
7	3.5															7
8	3.5															8
9	3.5															9
10	3.5															10
12	3.5															12
14	3.5			2.7												14
16	3.5			2.7			2.6			2.5						16
18	3.4	3		2.7			2.6			2.5			2.4			18
20	3.2	2.8		2.7			2.6			2.5			2.4			20
22	3	2.5		2.7			2.6			2.5			2.4			22
24	2.7	2.3		2.7	2.5		2.6			2.5			2.4			24
26	2.5	2.1	1.8	2.7	2.4		2.6	2.3		2.5			2.4			26
28	2.2	2	1.7	2.7	2.3		2.6	2.2		2.5	2.2		2.4			28
30	2.1	1.8	1.6	2.7	2.2		2.6	2.2		2.5	2.1		2.4	2.1		30
32	1.9	1.7	1.5	2.6	2.1	1.6	2.5	2.1		2.5	2.1		2.4	2		32
34	1.7	1.6	1.4	2.5	2	1.6	2.4	2.1	1.6	2.4	2		2.3	2		34
36	1.6	1.5	1.4	2.4	1.9	1.6	2.4	2	1.6	2.3	2	1.6	2.3	1.9		36
38	1.5	1.4	1.3	2.3	1.8	1.5	2.3	1.9	1.5	2.3	1.9	1.5	2.2	1.9	1.5	38
40	1.4	1.3		2.2	1.8	1.4	2.2	1.8	1.5	2.2	1.9	1.5	2.2	1.8	1.5	40
42	1.3	1.3		2.1	1.7	1.4	2.1	1.7	1.4	2.2	1.8	1.4	2.1	1.8	1.4	42
44				2	1.6	1.4	2	1.7	1.4	2.1	1.7	1.4	2.1	1.8	1.4	44
46				1.9	1.5	1.3	1.8	1.6	1.3	2	1.7	1.4	1.7	1.7	1.4	46
48				1.8	1.5	1.3	1.7	1.5	1.3	1.9	1.6	1.3	1.4	1.6	1.3	48
50				1.7	1.4	1.3	1.6	1.5	1.3	1.7	1.5	1.3	1.1	1.6	1.3	50
55				1.5	1.3	1.2	1.3	1.3	1.2	1	1.4	1.2		1.1	1.3	55
60							1	1.1	1.2		0.9	1.2			0.9	60
65																65
70																70
75																75
80																80
PARTS OF LINE	1	1	1	1	1	1	1	1	1	1	1	1	1	1	1	PARTS OF LINE

Load chart data is for reference, load charts supplied in the crane cab shall be used for lift planning.

**WP750 WORK PLATFORM ON MAIN BOOM RANGE CHART
FOR MANTIS MODEL GTC-1200**

as originally manufactured and equipped by Tadano Mantis Corporation

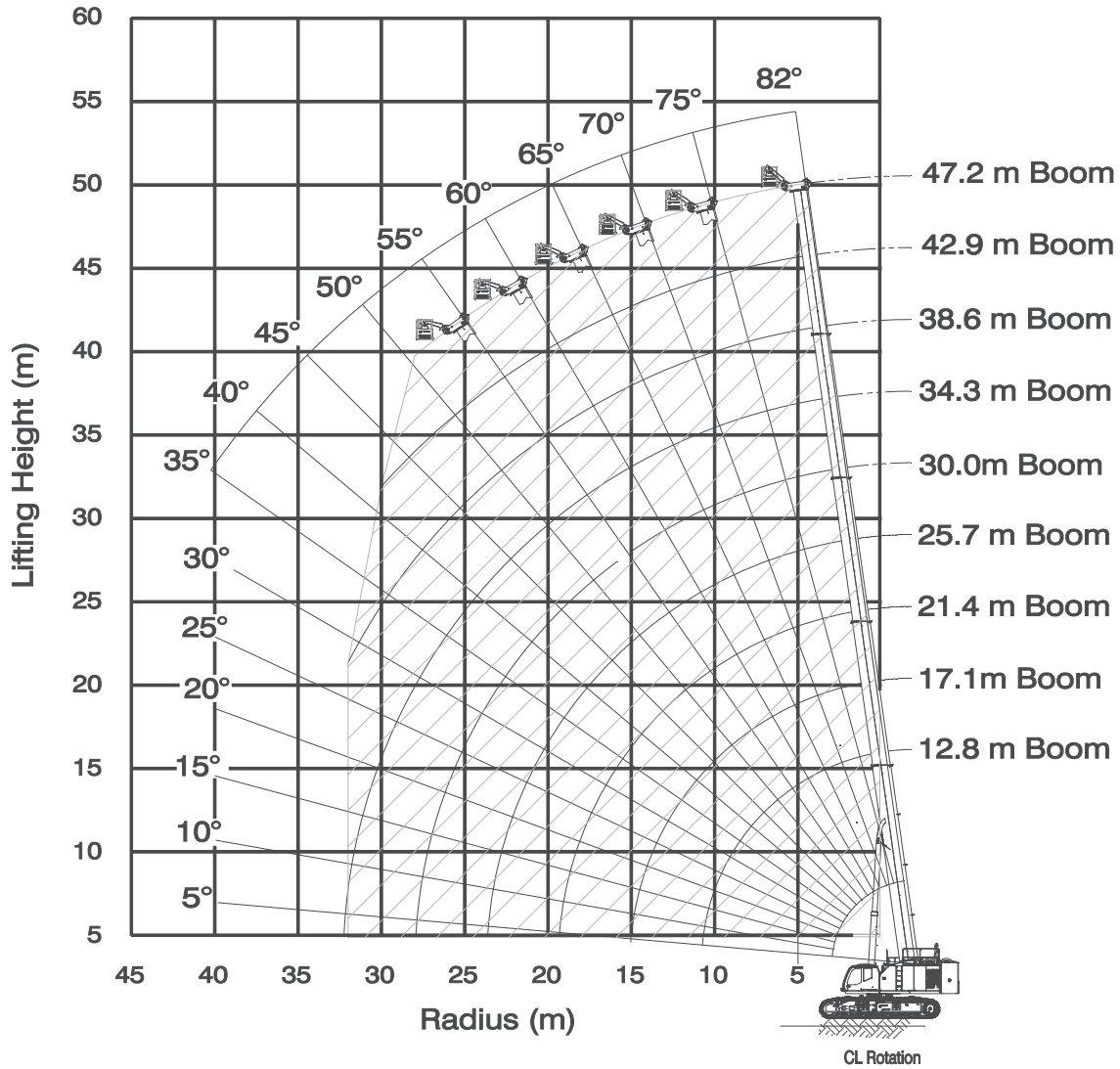

Shaded Area is Allowable Operating Range

Limits of operation:

Maximum load capacity = 340 kg

Maximum radius when mounted on main boom = 32m

Maximum occupancy = 2 persons

Notes:

1. It is permissible to leave the jib and extension stowed on the boom while operating with Work Platform mounted to the main boom.
2. The hook block(s) must be removed when using the Work Platform

WARNING: Lifting a load during Work Platform operation is **not** allowed.

WARNING: Travelling the crane with person(s) in the Work Platform is **not** allowed.

WP750 WORK PLATFORM ON 10.2 M EXTENSION RANGE CHART FOR MANTIS MODEL GTC-1200

as originally manufactured and equipped by Tadano Mantis Corporation

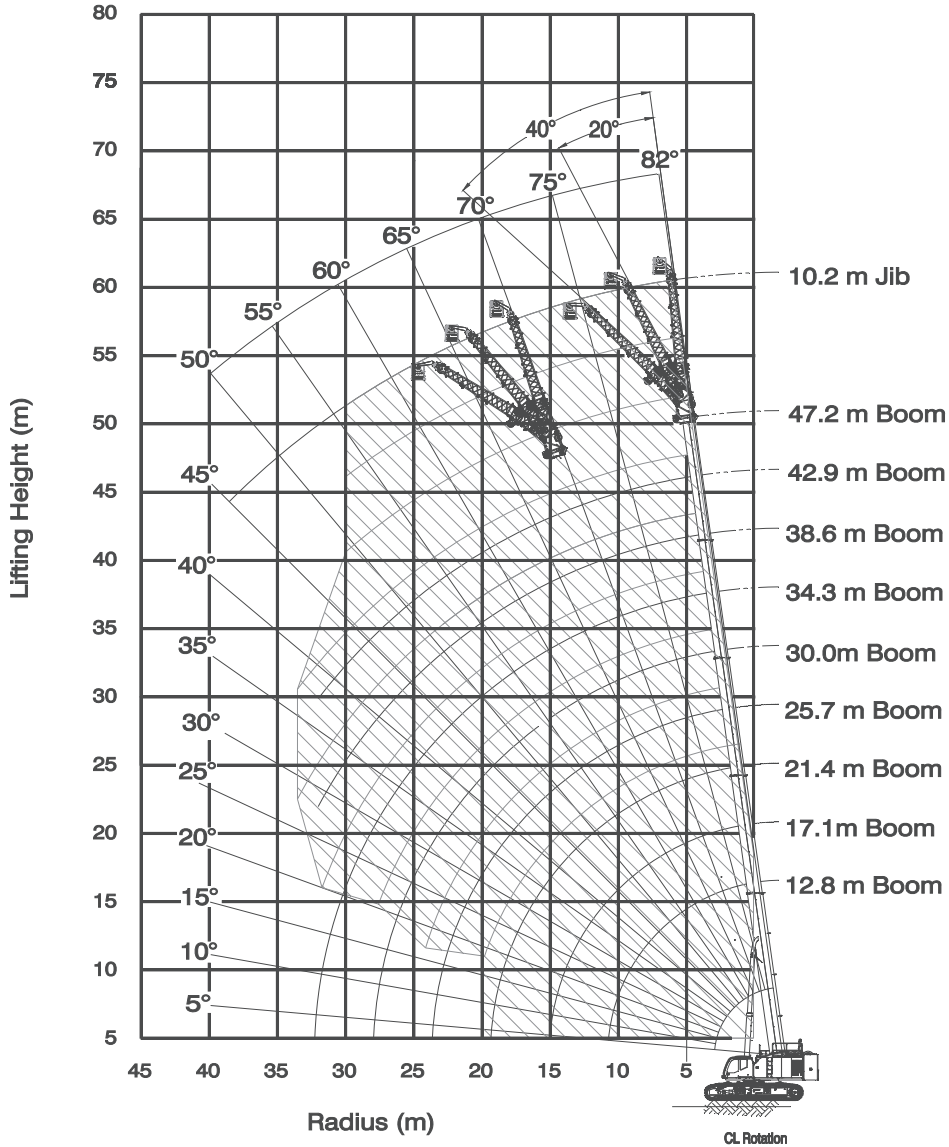

Shaded Area is Allowable Operating Range

Limits of operation:

Maximum load capacity = 340 kg

Minimum boom angle when mounted on 10.2m extension at 0° offset = 0°

Minimum boom angle when mounted on 10.2m extension at 20° offset = 20°

Minimum boom angle when mounted on 10.2m extension at 40° offset = 40°

Maximum occupancy = 2 persons

Notes:

1. It is permissible to leave the 7.8 m Extension section stowed on the boom while operating with Work Platform mounted to the 10.2m boom extension.
2. The hook block(s) must be removed when using the Work Platform

WARNING: Lifting Load during Work Platform operation is *not* allowed.

WARNING: Travelling the crane with person(s) in the Work Platform is *not* allowed.

PLEASE READ, UNDERSTAND, AND FOLLOW THE MANUALS FURNISHED WITH THE CRANE (OPERATORS AND SAFETY) AS WELL AS THE CAPACITY LIMITATIONS AND GENERAL CONDITIONS LISTED BELOW PRIOR TO OPERATION OF THE CRANE. FAILURE TO DO SO MAY RESULT IN AN ACCIDENT.

Performance of this TADANO MANTIS crane as manufactured by Tadano Mantis Corporation applies only to machines as originally equipped by manufacturer and in a properly maintained condition. Capacities given are maximum covered by the manufacturer's warranty and are based on a freely suspended load with NO allowance for factors as out-of-level operation (beyond the limits specified on the charts), supporting surface conditions, hazardous surroundings, experience of personnel, etc. The operator shall establish practical working loads based on prevailing operating conditions, such as, but not limited to the above.

The lifting capacities in the structural area are based on DIN 15018 parts 2 and 3 and F.E.M.

The lifting capacities in the stability area are based on DIN 15019 part 2 / ISO 4305 / EN 13000.

Maximum admissible wind velocity for working with telescopic boom is 36 km/hr. Consult TADANO MANTIS for ratings at higher wind speeds.

Side pull on boom is extremely dangerous and must be avoided.

DO NOT exceed manufacturer's maximum specified reeving.

Boom angle/boom length relationships given are an approximation of the resulted load radius, which should be an accurate measurement. Boom height dimensions are measured from ground to center of lower boom head sheave.

It is permissible to attempt to telescope boom with a load within the limits of rated capacities. However, boom angle system hydraulic pressure, and/or boom lubrication may affect operation.

It is permissible to travel with loads within the rated capacity of the crane. Travel speeds should be greatly reduced to reflect terrain limitations and minimize dynamic loads applied to the crane structure.

Lifting capacities are shown in metric tons.

The weight of load handling devices such as hook blocks, slings, etc., must be considered as part of the load and must be deducted from the lifting capacities.

The lifting capacities for the telescopic boom apply to a crane with no boom extensions being stowed or mounted on the crane.

The working radius is the horizontal distance from the center of rotation to the center of the freely suspended, non-oscillating load.

The lifting capacities are subject to change without prior notice.

The above remarks are for basic information only and the operator's manual must be consulted before operating this crane. All data and performances refer to the standard crane. The addition of optional and other equipment may affect the performance of the crane.

Load moment indicating and anti-two block systems are operator aids and must never be used in lieu of job site lift planning calculations by the operator which must take into account ground conditions, weather and all other environmental factors prevailing at the time of the lift. Specifications are subject to change at any time without prior notice and are for factory installation at the time of original manufacture. Illustrations and photographs may show optional equipment. Supersedes all previous issues.

TADANO MANTIS CORPORATION

1705 Columbia Avenue • Franklin, TN 37064 USA • Toll-Free: 1-800-272-3325 • Fax: 615-790-6803 • mantiscranes.com

TADANO Ltd., International Division

4-12, Kamezawa 2-chome,
Sumida-Ku, Tokyo 130-0014, Japan

Tel: +81 3 3621 7750

Fax: +81 3 3621 7785

E-mail: info@tadano.com

www.tadano.com

SPECIFICATION SHEET NO. TMC-DI-734-02-002-07/15-ISO