

ROUGH-TERRAIN CRANE RT60



ZOOMLION

CONTENTS

FEATURES	2
KEY/SYMBOLS	3
TECHNICAL DESCRIPTION	5-6
CRANE AND COMPONENT WEIGHTS	7
WORKING RANGE DIAGRAM	7
CRANE DIMENSIONS	8
LOAD CHARTS	9-14

FEATURES



The RT60 features a 43 m telescopic boom. Its telescoping system consists of a two-stage hydraulic cylinder with a rope extension mechanism.

Formed boom made with high yield steel which reduces the operating weight of the boom and maximizes performance.



We chose the AxleTech brand axle because AxleTech offers the most reliable product on the market and has years of experience in manufacturing mobile crane axles.



Full-vision operator cab is designed for maximum comfort and ease of operation.



The DANA 13.5HR 32662 transmission offers the latest technology for the diverse needs of off-road cranes.



The Cummins QSB 6.7 diesel engine is TIER-III compliant and is proven to have superior performance and durability.

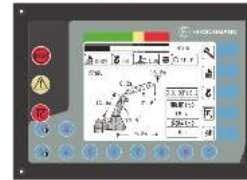

















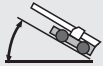



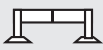

HIRSCHMANN HC4900 LMI (Load Moment Indicator), delivers the industry's most reliable electronic monitoring system available.

STANDARD EQUIPMENT

- Formed boom
- Offsettable jib 0° -20° -40°
- Auxiliary winch
- Cameras
- Auxiliary lifting sheave
- 60 ton hook block, with 5 sheaves and hook latch
- 5.5 ton hook ball, with hook latch
- Rotation-resistant wire rope
- Deluxe tilt seat
- Air conditioner/Heater
- Work light package : boom, cab and super structure
- Revolving amber light
- AM/FM radio
- Battery disconnect switch
- Front and rear lift lugs

ANSI & CE Standard

KEY/SYMBOLS

	Engine	p4		Transmission	p6
	Axles	p4		Cameras	p6
	Steering	p4		Brakes	p6
	Gradeability	p4		Main boom	p6
	Tires and wheels	p4		Hook ball	p6
	Outrigger system (100%, 50%, 0% extended)	p4		Hook block	p6
	Swing	p5		Main and auxiliary winches	p6
	Hydraulic system	p5		Crane with counterweight	p7
	Counterweight	p5		Side-stowed jib	p7
	Operator cab	p5		Distance from the hook to the head	p7
	Max. boom length with jib ext.	p5		Tip height	p7
	Load Moment Indicator(LMI)	p5		Working radius	p7

TECHNICAL DESCRIPTION



ENGINE

Cummins QSB 6.7) -----Inline 6 cylinder intercooled turbo diesel.
 Kilowatts KW(Hp) -----160(215)@2500rpm.
 Peak torque Nm(ft.lb.) ----- 888(655)@1500rpm
 303 liter(80 gal) fuel tank capacity

USA Federal EPA / California ARB / European EU / Tier III emission rating.



AXLES

AXLE-TECH front and rear steering axles with planetary reduction.

Front - Rigid mount.

Rear - Full-floating rear axle. Automatic rear axle oscillating lock occurs when superstructure is swung 10° from centerline in either direction



STEERING

Power steering with four independent modes:

- Front Wheel
- Rear-Wheel
- All-Wheel
- Crab



GRADEABILITY

144% max. gradeability
 5.20% max. gradeability



TIRES AND WHEELS

26.5x20-32 ply rating, earthmoving-style tires. Steel disc wheel.



OUTRIGGER SYSTEM

Four independent horizontal beams and vertical jacks with integral holding valves, each independently controlled from operator cab.

100% - Fully extended outriggers

footprint47.6sq.m(512.5 sq.ft.).

50% - Mid position outriggers

footprint33.32 sq.m(358.7 sq.ft.).

0% - Fully retracted outriggers

footprint19 sq.m(205 sq.ft.).

Pontoon diameter0.6 m (2.0 ft.).

Total floating ground bearing area1.1 sq. m (12.2 sq. ft.).

Outrigger spanLength 6.9 m (22.8 ft.). Width 6.9m (22.8).

TECHNICAL DESCRIPTION



SWING

Bi-directional hydraulic swing drive with multi-disc wet brake and planetary reduction gearbox. Spring-applied hydraulically released swing brake and 360° pneumatic positive swing lock.
Max. swing speed: 2.5 rpm.



HYDRAULIC SYSTEM

PERMCO hydraulic pumps:
Gear pump for main and auxiliary winches, boom hoist and telescope cylinders.
Gear pump for steering.
Gear pump for outriggers and slewing.
700 liter (185 gal) hydraulic reservoir with external sight and temperature gauge.
Easily accessible (10 micron) cartridge-style full-flow filters with bypass protection.
Max. operating pressure: 28 Mpa(4060 psi,279.9 bar)



COUNTERWEIGHT

Single 5000 kg (11, 000 lbs.) fixed counterweight.
Length2.6 m (8.5 ft).
Width0.6 m (1.9 ft).
Height0.7 m (2.3 ft).



OPERATOR CAB

Full-vision operator cab designed for maximum comfort. All steel fabrication with acoustical lining and safety glass throughout. The cab has a sliding door on the left and a sliding window on the right with a swing-up skylight with retractable shade and wiper motor. Fully adjustable deluxe seat with tilt. Foot controls for boom telescope, service brake and engine throttle. Tilt steering.

Temperature control is provided by a hydraulically driven air conditioning unit. Easy view dashboard with gauges for all engine sensors and rocker switch outrigger controls. Standard amenities also include bubble level, dome light, left-side rearview mirror, seat belt, travel swing lock and signal horn.



MAX. BOOM LENGTH WITH JIB EXTENSION

10-17 m (33-56 ft.) jib consisting of 10 m (33ft.) lattice side stow jib and 7 m (23 ft.) manual pull out section. Main jib is offsettable at 0°, 20° and 40°.

Max. tip height with 10m (33 ft.) jib erected is 46.6 m (153 ft.).

Max. tip height with 10m (33 ft.) jib + 7 m (23 ft.) fixed pullout extension is 52.4m (171.9 ft.).



LOAD MOMENT INDICATOR (LMI)

HIRSCHMANN HC4900 LMI control system. Microguard graphic display load moment and anti-two block system with audiovisual warning and function limiter.

System displays the following information: crane configuration, boom length, boom angle, load radius, allowed capacity, actual load, and load percentage of allowed capacity.

System includes settable work parameters: min./max. boom length, min./max. boom angle, defined swing area.



TRANSMISSION

Dana powershift transmission - 6 speeds forward and 3 speeds reverse.

Front axle disconnect offering both 4x4 and 4x2 operation.

Max. speed 41.4 km/hr(25.7 mph)



CAMERAS

The crane comes equipped with two cameras—a winch camera for viewing hoist operation and a rear camera for viewing the rear of the crane. The monitor is located in the cab and one can easily toggle between both camera views.



MAIN BOOM

Four-section, full-power synchronized boom. Boom is constructed of high-yield steel. 5 sheave quick reeve boom tip with removable rope guards. Rope termination lugs on both sides of boom head. Auxiliary lifting sheave and manual angle indicator are included.

Full extended boom length-----43m(141ft)
Full retracted boom length-----11.4m(37.4ft)
Max. tip height ,main boom-----45.4m(148.9ft)

Boom angle range (min./max.)-----3°/+78°
Boom raising /lowering time-----56 sec/63 sec
Boom extension/retraction time-----100 sec/80 sec



BRAKES

470 millimeters (18.5 in) diameter disc brakes on all wheels hydraulically operated.



HOKK BLOCK AND HOOK BALL

60-ton ,5 sheave(steel),-----

Hook block weight ----- 642kg(1412 lbs)

5.5-ton top swivel -----

Hook ball weight-----120kg(264 lbs)



MAIN AND AUXILIARY WINCHES

Standard two speed main and auxiliary hoists, each with planetary reduction and spring applied multi-disc wet brake.

Each hoist features

Grooved drum lagging.

Hoist drum cable followers.

Max. permissible line pull: 7,000 kg (15,432 lbs.).

Winch speed: 0 - 150 m/min (0 - 492 fpm).





Power up / power down

Electronic drum rotation indicators.

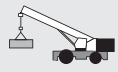
Rope construction: 19 mm (0.75 in.) rotation-resistant compacted strand.

CRANE AND COMPONENT WEIGHTS

CRANE OPERATING WEIGHTS						
 CRANE WITH CTWT.	Gross Vehicle Weight		Front Axle Load		Rear Axle Load	
	Kg	lb	Kg	lb	Kg	lb
	44,260	97,372	25,220	62,084	19,040	41,888

DEDUCTIONS FOR LOAD HANDLING				
	 JIB STOWED	 AXUE LARY HEAD	 5 sheave 60-ton hook block	 5.5-ton hook ball
Kg	952	55	642	120
lb	2099	121	1412	264

FRONT WHEEL (4X2) STEERING	METRIC	IMPERIAL
Wall to wall over boom attached	15.7 m	51.5ft
Wall to wall over carrier	13.1 m	43ft
curb to curb	12.3m	40.4ft
ALL WHEEL (4X4) STEETING	METRIC	IMPERIAL
Wall to wall over boom attached	11.1 m	36.4ft
Wall to wall over carrier	8.1 m	26.6ft
curb to curb	7.3m	23.9ft
Tail Swing	METRIC	IMPERIAL
Wall to wall over boom attached	3.78m	12.4ft

WORKING RANGE DIAGRM

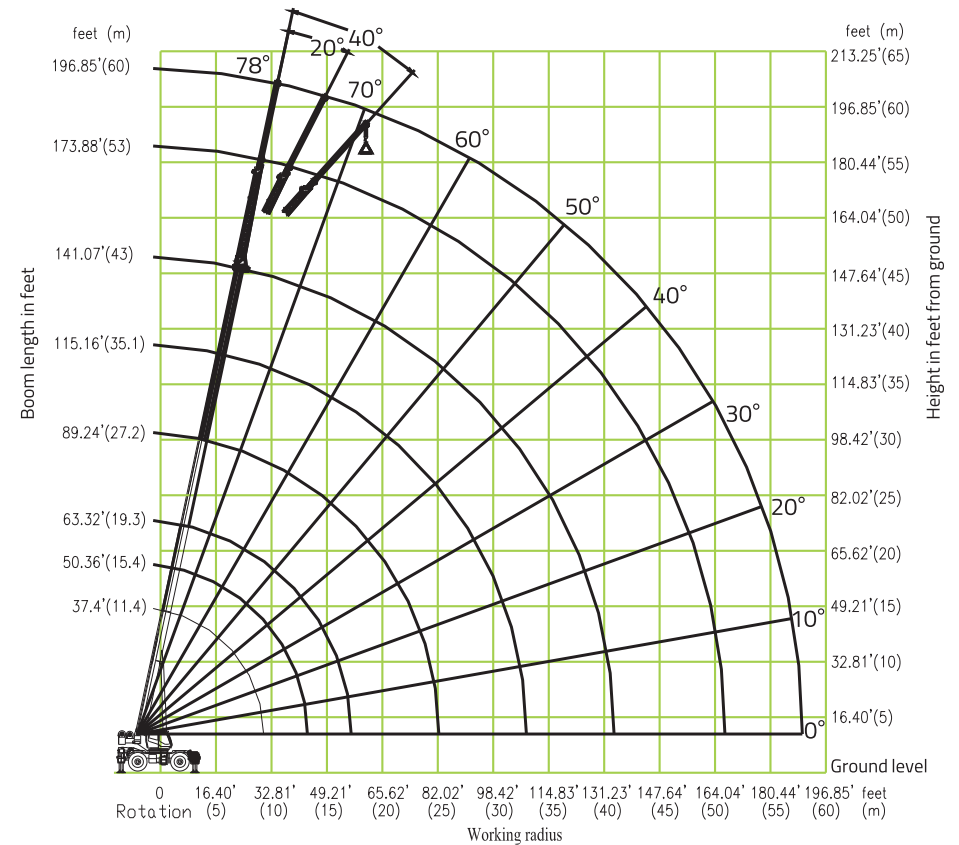

CRANE DIMENSIONS

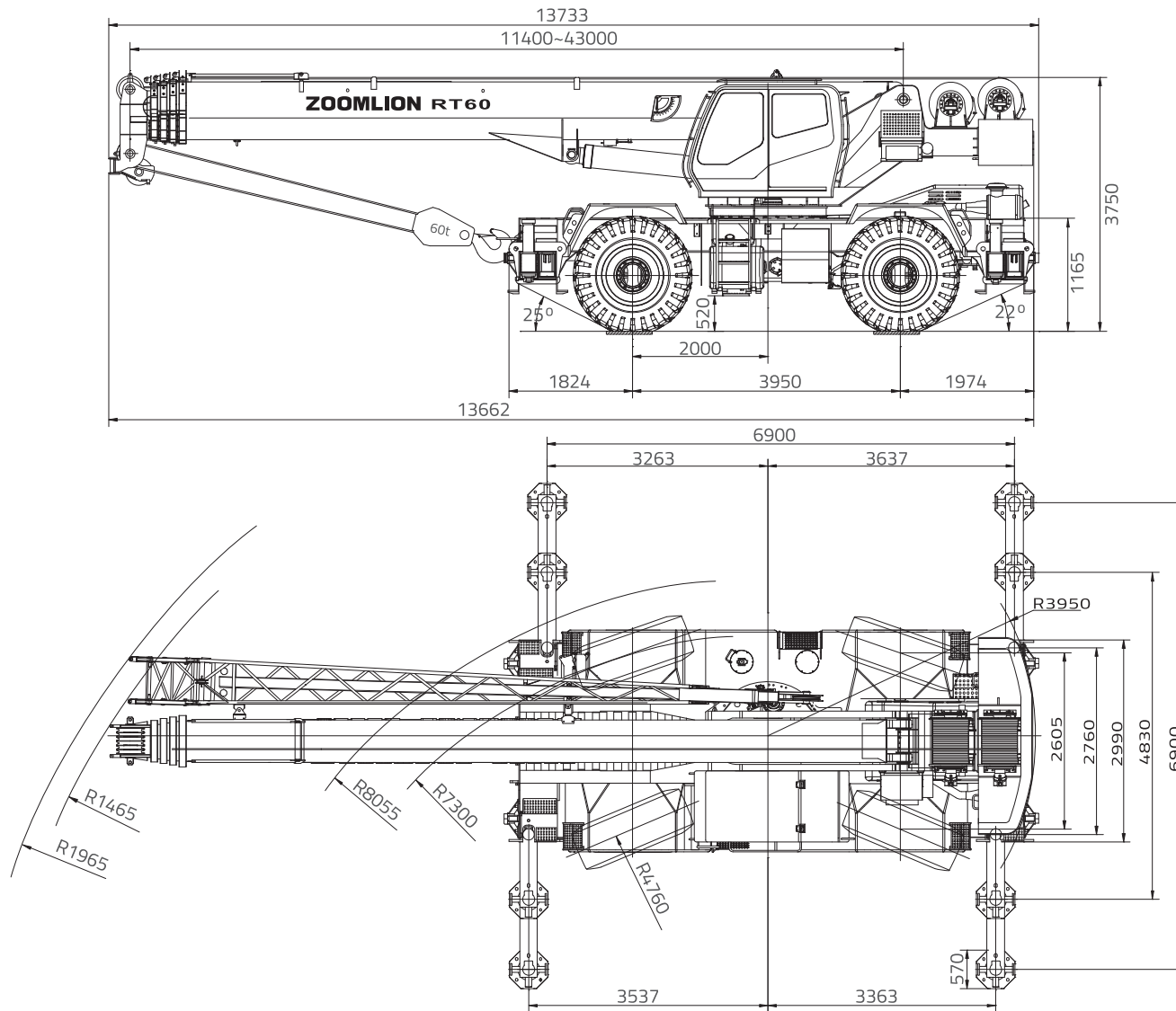



LIFTS WITH OUTRIGGER BEAMS FULLY EXTENDED

5000kg.ctwt

ANSI B30.5
EN13000

75%

360°(UNIT:KG)

MAIN BOOM RATED LOADS

BOOM LENGTH (mm)	11400		15350		19300		27200		35100		43000	
	Boom Angle (°)	360° (KG)	Boom Angle (°)	360° (KG)	Boom Angle (°)	360° (KG)	Boom Angle (°)	360° (KG)	Boom Angle (°)	360° (KG)	Boom Angle (°)	360° (KG)
2800	70.1	60000										
3000	68.5	55000	74.3	45000	77.6	35000						
3500	65.7	51150	72.3	45000	76.1	35000						
4000	62.8	47150	70.3	42690	74.5	35000						
4500	59.8	42800	68.3	39890	73.0	32950						
5000	56.7	39100	66.2	37440	71.4	30950	76.9	20590				
5500	53.4	35900	64.1	35240	69.8	29150	75.9	20590				
6000	50.0	33080	61.9	32690	68.1	27550	74.8	20590				
6500	46.4	30650	59.7	30240	66.5	26100	73.7	19640	77.4	13590		
7000	42.5	28460	57.5	28040	64.8	24800	72.5	18790	76.6	13590		
7500	38.2	26560	55.1	26150	63.2	23600	71.4	18040	75.7	13590		
8000	33.4	24000	52.7	23340	61.4	22500	70.3	17340	74.9	13590	77.7	9190
9000	20.2	18960	47.6	18390	57.9	17960	68.0	16040	73.2	12840	76.4	9190
9433	0	16160										
10000			42.0	14950	54.2	14510	65.7	14890	71.5	12090	75.0	8690
11000			35.6	12360	50.3	11950	63.3	13040	69.7	11490	73.6	8190
12000			27.7	10370	46.2	10000	60.9	11050	67.9	10840	72.2	7740
13375			0	8280								
14000					36.7	7200	55.8	8200	64.3	8630	69.3	7040
16000					23.9	5280	50.4	6260	60.6	6680	66.4	6390
17320					0	4300						
18000							44.6	4850	56.7	5270	63.5	5490
20000							37.9	3780	52.6	4200	60.4	4430
22000							30.0	2940	48.3	3360	57.3	3590
24000							19.0	2260	43.7	2690	54.0	2910
26000									38.5	2130	50.6	2360
28000									32.7	1670	46.9	1900
30000									25.7	1280	43.1	1510
32000									15.9	940	38.9	1170



LIFTS WITH OUTRIGGER BEAMS FULLY EXTENDED

5000kg.ctwt

ANSI B30.5
EN13000

75%

360°(UNIT:KG)

10 M JIB RATED LOADS

Boom angle (°)	0° OFFSET		20° OFFSET		40° OFFSET	
	LOAD Radius (mm)	360° (KG)	LOAD Radius (mm)	360° (KG)	LOAD Radius (mm)	360° (KG)
78	9020	5140	11887	2840	14186	2090
76	10823	4740	13648	2740	15873	2040
74	12610	4390	15389	2640	17538	1990
72	14379	4090	17110	2540	19179	1940
70	16128	3840	18807	2440	20795	1890
68	17856	3640	20478	2340	22382	1840
66	19559	3440	22123	2290	23940	1840
64	21235	3240	23738	2240	25467	1790
62	22884	3090	25321	2140	26960	1790
60	24502	2940	26871	2090	28418	1740
58	26088	2540	28386	2040	29838	1740
56	27640	2190	29864	1990	31220	1740
54	29155	1890	31304	1740	32561	1650
52	30633	1630	32702	1510	33861	1440
50	32071	1400	34059	1310	35116	1250
48	33467	1200	35371	1130	36327	1080
46	34820	1030	36638	970	37490	930
44	36128	870	37858	820	38606	790

LIFTS WITH OUTRIGGER BEAMS FULLY EXTENDED						
		5000kg.ctwt	ANSI B30.5 EN13000	75%	360°(UNIT:KG)	
17 M JIB RATED LOADS						
Boom angle (°)	0° OFFSET		20° OFFSET		40° OFFSET	
	LOAD Radius (mm)	360° (KG)	LOAD Radius (mm)	360° (KG)	LOAD Radius (mm)	360° (KG)
78	10475	2640	15596	1390	19700	1040
76	12516	2390	17561	1340	21534	990
74	14539	2240	19503	1290	23339	990
72	16541	2090	21418	1240	25114	940
70	18522	1940	23305	1190	26855	940
68	20477	1840	25161	1190	28561	940
66	22405	1740	26984	1140	30230	890
64	24303	1640	28771	1090	31860	890
62	26169	1540	30521	1090	33448	890
60	28001	1490	32232	1040	34993	890
58	29796	1390	33901	1040	36493	890
56	31553	1340	35526	990	37947	840
54	33268	1290	37105	990	39351	840
52	34941	1240	38637	940	40706	840
50	36569	1180	40119	940	42008	840
48	38149	1010	41550	910	43256	840
46	39681	860	42927	780	44450	730
44	41162	720	44250	660	45587	620



LIFTS WITH OUTRIGGER BEAMS AT MID-POSITION

5000kg.ctwt

ANSI B30.5
EN13000

75%

360°(UNIT:KG)

MAIN BOOM RATED LOADS

BOOM LENGTH (mm)	11400		15350		19300		27200		35100		43000	
	Boom Angle (°)	360° (KG)	Boom Angle (°)	360° (KG)	Boom Angle (°)	360° (KG)	Boom Angle (°)	360° (KG)	Boom Angle (°)	360° (KG)	Boom Angle (°)	360° (KG)
3000	68.5	51050	74.3	45000	77.6	35000						
3500	65.7	45350	72.3	44940	76.1	35000						
4000	62.8	40650	70.3	40190	74.5	35000						
4500	59.8	36700	68.3	36240	73.0	32950						
5000	56.7	33350	66.2	32890	71.4	30950	76.9	20590				
5500	53.4	28370	64.1	27620	69.8	27030	75.9	20590				
6000	50.0	23910	61.9	23230	68.1	22690	74.8	20590				
6500	46.4	20540	59.7	19910	66.5	19420	73.7	19640	77.4	13590		
7000	42.5	17910	57.5	17320	64.8	16870	72.5	17830	76.6	13590		
7500	38.2	15800	55.1	15240	63.2	14760	71.4	15750	75.7	13590		
8000	33.4	14060	52.7	13490	61.4	13020	70.3	14040	74.9	13590	77.7	9190
9000	20.2	11310	47.6	10760	57.9	10340	68.0	11350	73.2	11740	76.4	9190
9433	0	10370										
10000			42.0	8750	54.2	8360	65.7	9340	71.5	9730	75.0	8690
11000			35.6	7200	50.3	6840	63.3	7790	69.7	8180	73.6	8190
12000			27.7	5970	46.2	5630	60.9	6570	67.9	6950	72.2	7140
13375			0	4620								
14000					36.7	3830	55.8	4750	64.3	5140	69.3	5330
16000					23.9	2560	50.4	3460	60.6	3850	66.4	4050
17320					0	1890						
18000							44.6	2500	56.7	2900	63.5	3100
20000							37.9	1760	52.6	2160	60.4	2370
22000							30.0	1170	48.3	1580	57.3	1790
24000									43.7	1100	54.0	1310



LIFTS WITH OUTRIGGER BEAMS FULLY RETRACTED

5000kg.ctwt

ANSI B30.5
EN13000

75%

360°(UNIT:KG)

MAIN BOOM RATED LOADS

BOOM LENGTH (mm)	11400		15350		19300		27200		35100		43000	
	Boom Angle (°)	360° (KG)	Boom Angle (°)	360° (KG)	Boom Angle (°)	360° (KG)	Boom Angle (°)	360° (KG)	Boom Angle (°)	360° (KG)	Boom Angle (°)	360° (KG)
3000	68.5	40960	74.3	39640	77.6	35000						
3500	65.7	30170	72.3	29340	76.1	28650						
4000	62.8	23710	70.3	22990	74.5	22390						
4500	59.8	19330	68.3	18680	73.0	18160						
5000	56.7	16170	66.2	15580	71.4	15080	76.9	15970				
5500	53.4	13780	64.1	13210	69.8	12700	75.9	13620				
6000	50.0	11910	61.9	11300	68.1	10820	74.8	11770				
6500	46.4	10350	59.7	9760	66.5	9310	73.7	10240	77.4	10570		
7000	42.5	9060	57.5	8500	64.8	8070	72.5	8980	76.6	9310		
7500	38.2	7980	55.1	7440	63.2	7020	71.4	7920	75.7	8260		
8000	33.4	7060	52.7	6540	61.4	6140	70.3	7030	74.9	7360	77.7	7490
9000	20.2	5570	47.6	5080	57.9	4710	68.0	5580	73.2	5920	76.4	6060
9433	0	5030										
10000			42.0	3960	54.2	3610	65.7	4470	71.5	4810	75.0	4960
11000			35.6	3070	50.3	2740	63.3	3590	69.7	3940	73.6	4100
12000			27.7	2350	46.2	2030	60.9	2880	67.9	3220	72.2	3390
13375			0	1520								
14000							55.8	1790	64.3	2140	69.3	2310
16000									60.6	1350	66.4	1540

LIFTS ON TIRES												
5000kg.ctwt	ANSI B30.5 EN13000				75%				UNIT:KG			
MAIN BOOM RATED LOADS												
BOOM LENGTH (mm)	11400				15350				19300			
	LOAD RADIUS (mm)	Boom Angle (°)	360° (KG)	Station-ary Over Front	Pick & Carry	Boom Angle (°)	360° (KG)	Station-ary Over Front	Pick & Carry	Boom Angle (°)	360° (KG)	Station-ary Over Front
3000	68.5	21000	26800	20400	74.3	20460	26350	19900	77.6	19950	25900	19500
3500	65.7	18050	23800	18010	72.3	17500	23350	17550	76.1	17030	22950	17160
4000	62.8	15670	21300	16010	70.3	15120	20850	15550	74.5	14700	20470	15180
4500	59.8	13740	19200	14360	68.3	13210	18740	13920	73.0	12800	18380	13510
5000	56.7	12160	17410	12950	66.2	11630	16940	12480	71.4	11220	16610	12140
5500	53.4	10780	15870	11690	64.1	10290	15420	11280	69.8	9840	15040	10880
6000	50.0	9650	14520	10640	61.9	9100	14060	10180	68.1	8730	13740	9820
6500	46.4	8630	13350	9700	59.7	8110	12880	9260	66.5	7760	12540	8890
7000	42.5	7770	12280	8850	57.5	7260	11850	8410	64.8	6880	11520	8090
7500	38.2	6990	11360	8120	55.1	6510	10920	7660	63.2	6100	10570	7310
8000	33.4	6320	10490	7450	52.7	5800	10070	7010	61.4	5460	9740	6680
9000	20.2	5100	9030	6290	47.6	4670	8610	5840	57.9	4300	8310	5540
9433	0	4690	8500	5850								
10000					42.0	3650	7100	4910	54.2	3300	6730	4580
11000					35.6	2800	5800	4100	50.3	2470	5450	3800
12000					27.7	2100	4760	3420	46.2	1790	4430	3080
14000									36.7	—	2900	2010
16000									23.9	—	1790	1120

Note:

The crane is stationary when it is in the 360° full range operation and in the operation over front.

ZOOMLION

Zoomlion Heavy Industry Science & Technology Co.,Ltd.

Add: No.677, Lugu Road, Zoomlion Industrial Park, Changsha, Hunan, China, 410205

Copyright©2017 Zoomlion. All rights reserved. Reproduction and copying of any part of contents is not allowed for any purposes without Zoomlion's approval.

